

ecovent[®] counterflow

- ▶ Premium efficiency heat recovery
- ▶ ErP 1253/2014 2018 compliant
- ▶ Heat recovery efficiency up to 90%
- ▶ Plantroom and weatherproof options
- ▶ Fully optimised low energy EC fans
- ▶ Low SFP to exceed L2 building regulations
- ▶ High quality case construction to BS EN 1886
- ▶ Low noise to help meet acoustic requirements, including BB93
- ▶ Fitted BlueSense controls for simple installation
- ▶ BIM files available



**DUTIES UP TO
0.70 m³/s
(700 l/s)**



ecovent[®] counterflow
*part of a complete range of innovative, flexible products
from the HVAC experts*

ecovent[®] counterflow

For over a decade, **ecovent** has maintained its position as the recognised market leader in heat recovery air handling units. The premium efficiency heat recovery range offers units with capacities of up to 0.7 m³/s, featuring both low Specific Fan Power and energy consumption, along with high-efficiency fans.

Designed to accommodate a diverse range of installations such as offices, schools, hotels, and retail establishments, the **ecovent** counterflow range is versatile enough to meet any application's needs. Whether for ceiling voids, plant rooms, or external locations, the range offers a variety of models and control options, ensuring there's an **ecovent** unit suitable for every setting.

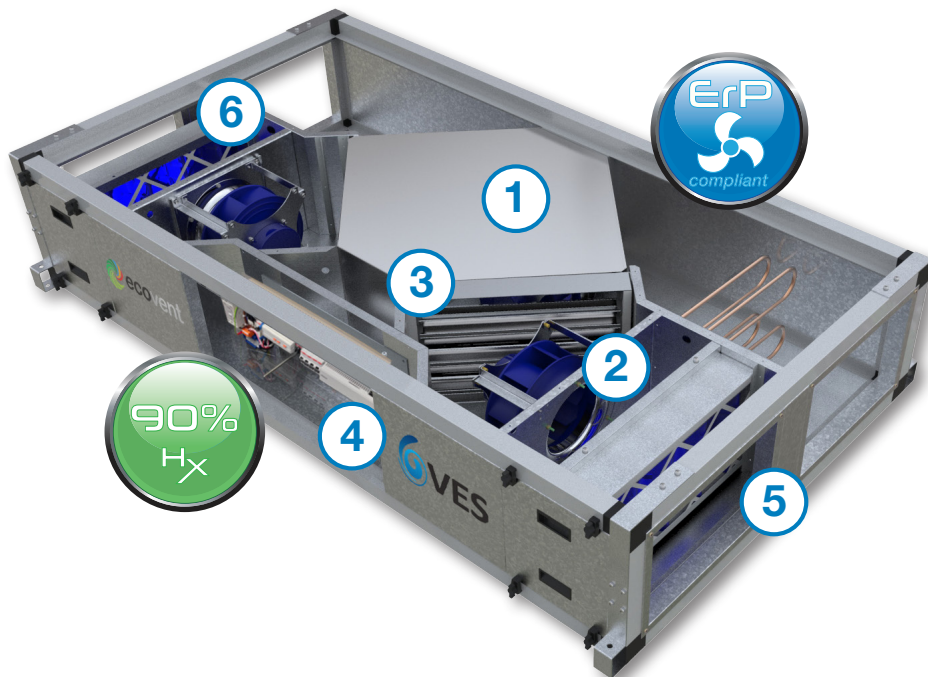

Duty performance curves

ecovent[®] counterflow Performance

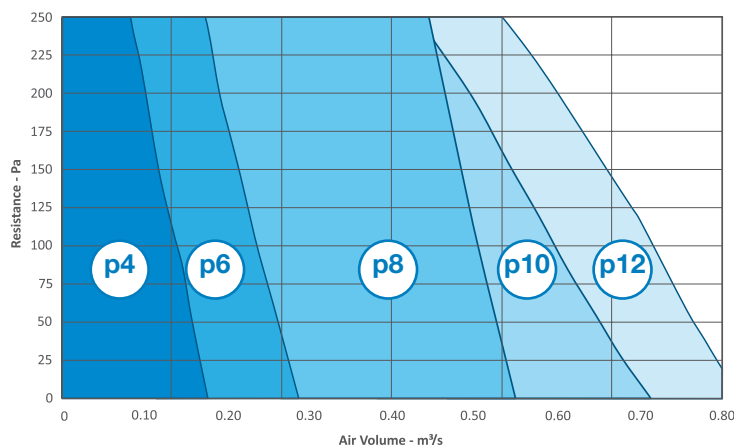

- Pre-wired/Fitted Controls
- Demand Ventilation
- Case Construction
- Filters
- CO₂ VOC Air Quality
- Thyristor Heater
- Energy Efficient Fans
- Speed Control
- Plug & Play
- Humidity
- Temperature
- Heat Recovery

Energy Saving

Intelligent controls enhance performance whilst saving energy and money.

premium efficiency heat recovery units

ecovent® Features and Benefits

Energy Saving

Meet regulations, minimise noise and maximise performance.

Energy saving packages combine intelligent controls technology, products and services.

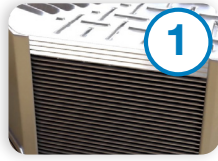

Premium Efficiency Heat Recovery

Using the latest Computational Fluid Dynamics simulations, the counterflow plate heat exchangers in ecovent counterflow units have been designed to optimise airflow. This enables a true rate of heat transfer, giving efficiencies of up to 90% to BS EN 308:2022 specification and exceeding ErP requirements. The ecovent counterflow range also achieves zero cross contamination of moisture, smells or fumes.



Energy Efficient

Energy efficient units with low SFPs to help achieve L2 Building Regulations. Units are fully tested to BS EN ISO 5801:2017 (airside performance).



Noise Reduction

Independently tested to BS EN ISO 3744:2010, units can help meet acoustic requirements for sensitive applications including BB93 (School Acoustics).



High Performance Fans

EC fan speed control allows for precise adjustment of airflow. This is important in applications where maintaining a specific temperature, humidity, or ventilation rate is critical.

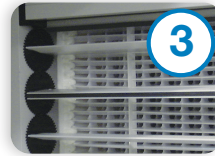

Face & Bypass Damper

Modulating damper to efficiently control the heating/cooling recovery.

Simple Installation and Maintenance

Simple connection and pre-installed features save onsite costs and reduce lead times. Carefully designed maintenance features minimise downtime and total cost of ownership.

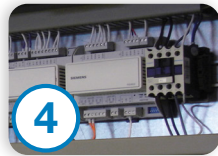

Pre-wired Controls

Energy saving packages combine intelligent technologies. The unit is pre-wired to an integral controls package to reduce onsite wiring requirements.

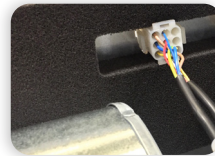

'Plug & Play' Fans

Fans are fitted with a quick change plug connector for easy maintenance. The fans feature EC motors and are balanced to G 2.5 / G 6.3 according to ISO 21940-11.

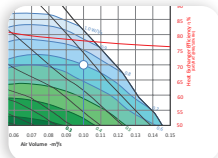

Airflow Commissioning

Volumes for supply or extract can be adjusted at the user interface, allowing more control of demand ventilation and night set back volume.

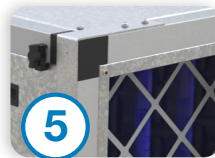

Duct Connections

Easy duct connections suitable for quick on site ductwork connection ensures an efficient fit whilst minimising potential noise breakout.

Versatile Options

Versatile location, handing and access options meet the widest range of project requirements

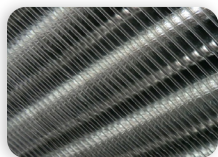

Heating Options

A variety of modulating low pressure hot water (LPHW) and electric heater options are available to suit the required application.



Filter Options

Filters are pleated media as standard, to BS EN ISO 16890 classification Coarse 65% (G4 EN 779:2012), with optional supply filters to ePM1 55% (F7 EN 779:2012).

Robust Construction

Excellent build quality ensures minimal noise breakout, low SFPs and airtight performance



Case Construction

Double skinned cases, flat and stacked configuration. All units built with an aluminium tubular frame and galvanised steel sheet panels, with resin bonded mineral wool slab infill.

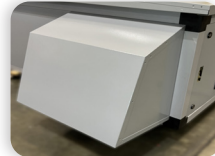

Weatherproof Options

Weatherproof units feature lids and bolt-on cowls, giving the ability to reposition these elements for a custom fit to suit site requirements.

BlueSense Energy Saving Package



ecovent Counterflow with integral controls



EC fan with full control



Sensor options



The sign of energy saving products, services and expertise

Selection data

ecovent EVCB074-1

Performance

$$\text{SFP} = \frac{\text{Electrical input power (Watts)}}{\text{Air volume flow rate (litres/second)}}$$

Note: SFP figures quoted at voltages tested in accordance with BS EN ISO 5801:2017 for each of the two fans.

Tolerances:
 On flow rates: +/- 5%
 On acoustic power and pressure: Levels: +/- 3 dB
 By octave band: +/- 5 dB

Heat exchanger efficiency is calculated based upon EAT -5 °C and RAT +20 °C.
 The fan performance is calculated using standard G4 filters (BS EN ISO 16890 Coarse 65%).

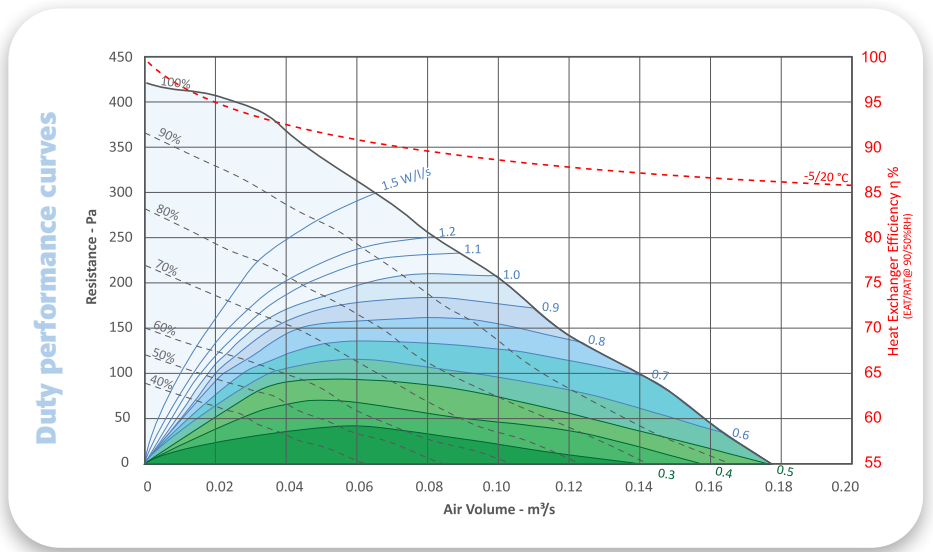

Size	Phase	Motor Size	Voltage	Fan Speed	Motor Full Load Current	Speed Control
EVCB074-1	1 Phase	0.100 kW	230 VAC	1410 rpm	0.83 A	EC

Acoustic data

Fan Speed	Sound Power Levels	Frequency (Hz)								Casing Radiated			
		63	125	250	500	1k	2k	4k	8k	NR@1m	NR@3m	dBA@1m	dBA@3m
100%	Casing Radiated	72	67	56	43	41	39	35	32	35	27	39	32
	Intake	58	64	62	54	59	57	51	45				
	Outlet	77	59	54	45	56	52	41	27				
80%	Casing Radiated	66	61	50	38	38	34	31	31	29	21	34	27
	Intake	53	58	55	51	56	51	48	42				
	Outlet	69	51	46	41	52	46	36	23				
60%	Casing Radiated	60	55	44	33	32	29	29	31	24	17	28	21
	Intake	44	53	46	50	49	46	44	37				
	Outlet	58	45	37	40	46	41	32	19				
40%	Casing Radiated	54	49	38	38	24	24	25	30	23	16	24	17
	Intake	40	48	37	51	42	39	33	24				
	Outlet	46	40	29	41	38	33	22	7				

Sound Spectrum dB re 10⁻¹² W pWL. Units are independently tested at ISVR in accordance with BS EN ISO 3744:2010

Unit dimensions

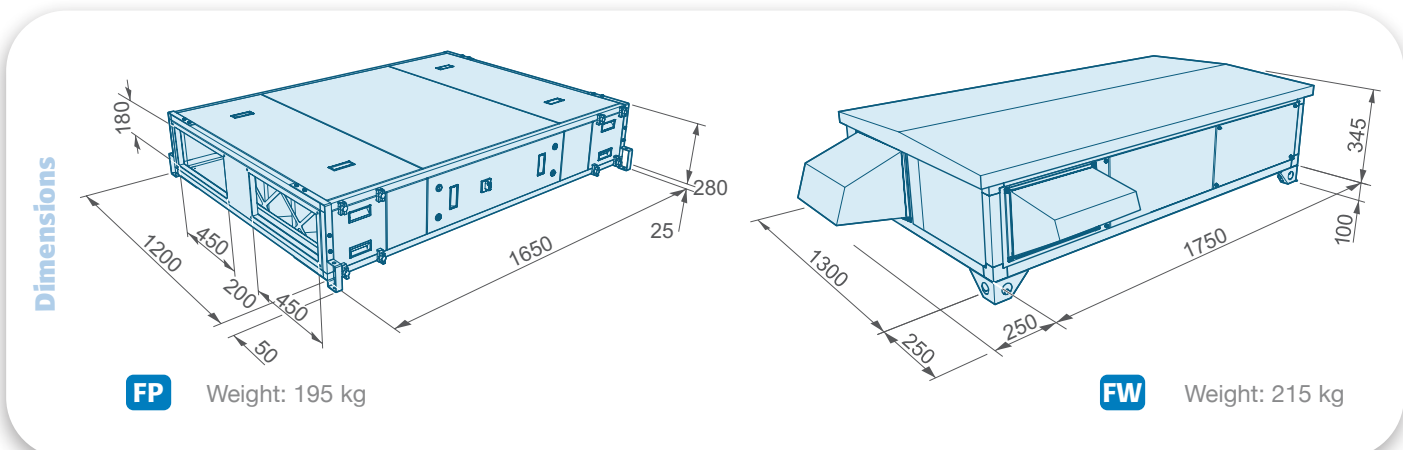

Note: Data for design guidance only. Detailed information is available upon request.

LPHW Heating data

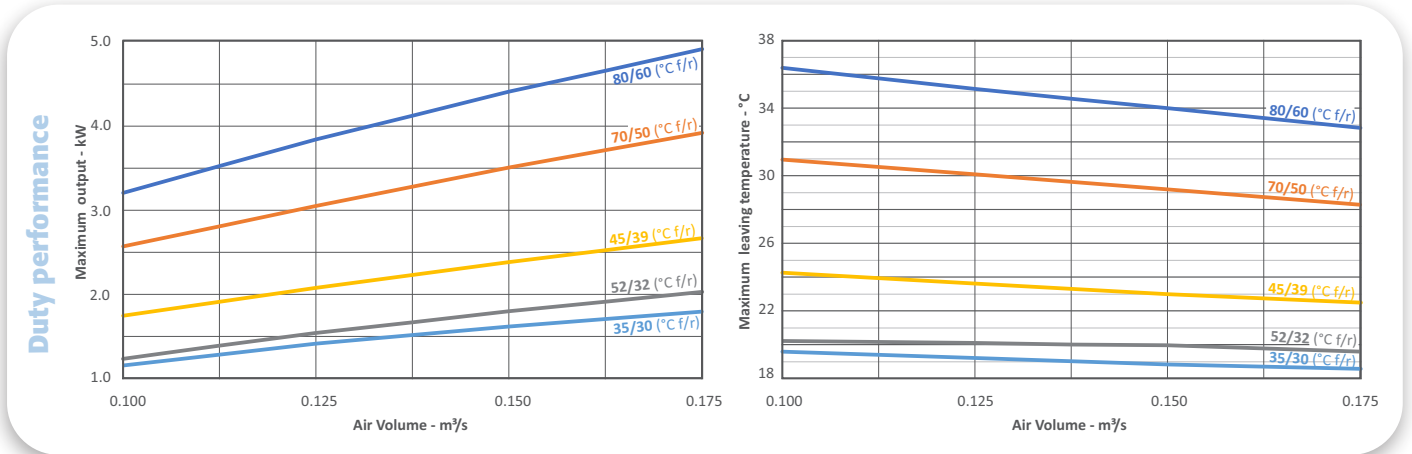

EVCBCL1000	Flow/Return °C	Air Volume m³/s	Max Leaving Temperature °C	Max Output kW	Water Flow Rate l/s	Water Pressure Drop kPa	Air Pressure Drop Pa
	80/60	0.100	36.5	3.2	0.039	3.0	8
		0.125	35.2	3.8	0.047	3.0	11
		0.150	34.1	4.4	0.053	3.0	16
	70/50	0.100	31.1	2.6	0.031	3.0	8
		0.125	30.2	3.1	0.037	3.0	11
		0.150	29.3	3.5	0.043	3.0	15

EVCBCL1000	Flow/Return °C	Air Volume m³/s	Max Leaving Temperature °C	Max Output kW	Water Flow Rate l/s	Water Pressure Drop kPa	Air Pressure Drop Pa
	52/32	0.100	20.3	1.3	0.015	3.0	8
		0.125	20.2	1.6	0.019	3.0	11
		0.150	20.0	1.8	0.022	3.0	15
	45/39	0.100	24.3	1.7	0.070	3.9	8
		0.125	23.7	2.1	0.084	5.5	11
		0.150	23.1	2.4	0.096	7.1	15
35/30	0.100	19.7	1.2	0.057	3.0	8	
	0.125	19.3	1.4	0.068	3.8	11	
	0.150	18.9	1.6	0.078	5.0	15	

Air off temperature based upon 10 °C taken after the heat exchanger (approximately entering air FAT -5 °C, RAT 12 °C)
Coil construction copper tubes, aluminium fins, coil connections 1/2" BSP.

UNIT EVCB074-1

EHB Heating data

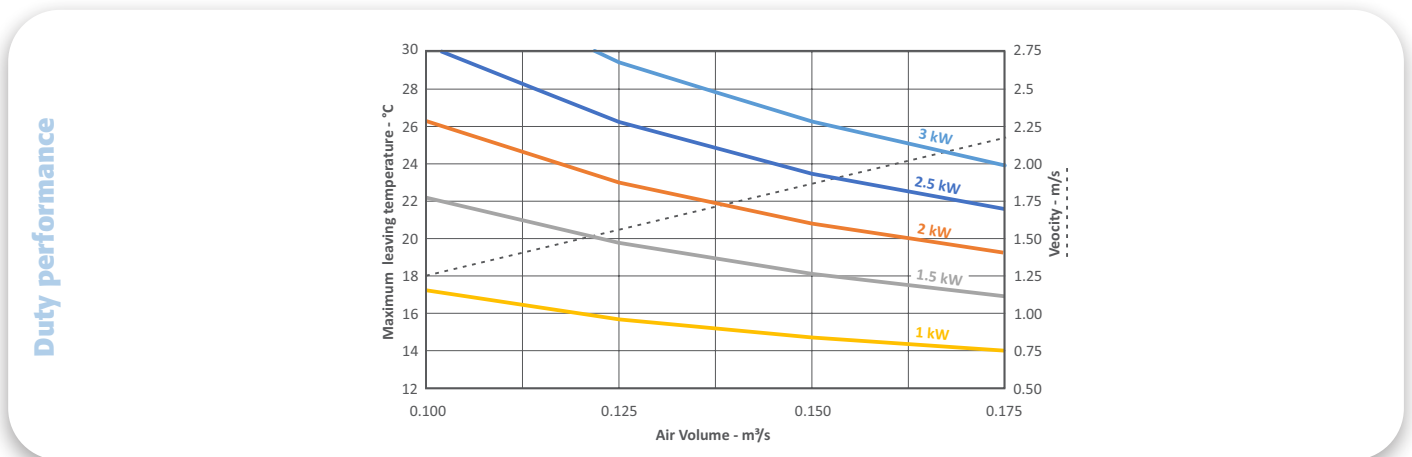

Air Volume m³/s	Maximum Leaving Air Temp °C	Maximum kW Output	1ph - Electric Heater	3ph - Electric Heater
0.100	22.2	1.5	EHEVC0/1.5KW/1X1	n/a
0.125	23.0	2.0	EHEVC0/2KW/1X1	
0.150	23.6	2.5	EHEVC0/2.5KW/1X1	

Air off temperature based upon 10 °C taken after the heat exchanger (approximately entering air FAT -5 °C, RAT 12 °C)
Power = Air Volume x Constant x Temperature Rise. kW = m³/s x 1.21 x ΔT °C.
Note: If no control panel is purchased the unit will be supplied with a main isolator.

Note: Data for design guidance only. Detailed information is available upon request.

Selection data

ecovent EVCB174-1

Performance

$$\text{SFP} = \frac{\text{Electrical input power (Watts)}}{\text{Air volume flow rate (litres/second)}}$$

Note: SFP figures quoted at voltages tested in accordance with BS EN ISO 5801:2017 for each of the two fans.

Tolerances:
 On flow rates: +/- 5%
 On acoustic power and pressure: Levels: +/- 3 dB
 By octave band: +/- 5 dB

Heat exchanger efficiency is calculated based upon EAT -5 °C and RAT +20 °C.
 The fan performance is calculated using standard G4 filters (BS EN ISO 16890 Coarse 65%).

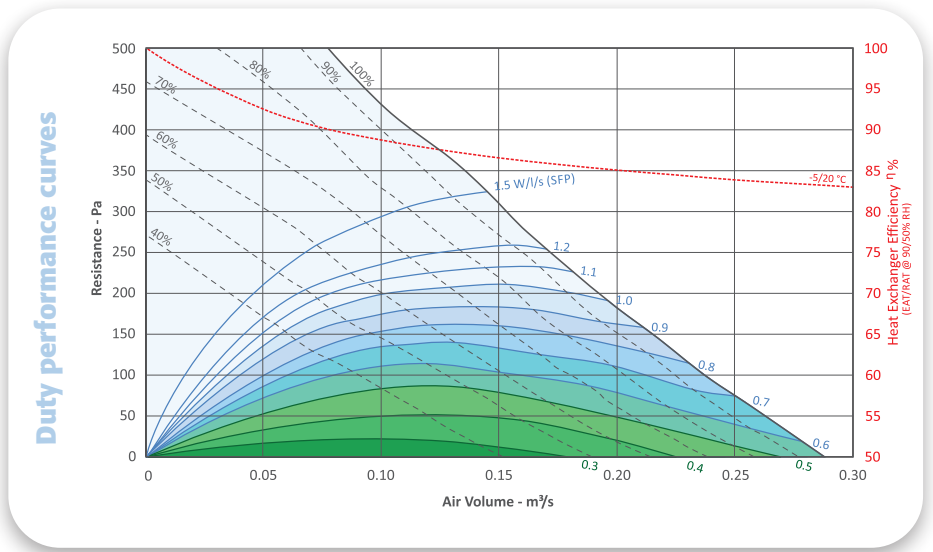

Size	Phase	Motor Size	Voltage	Fan Speed	Motor Full Load Current	Speed Control
EVCB174-1	1 Phase	0.100 kW	230 VAC	1410 rpm	0.83 A	EC

Acoustic data

Fan Speed	Sound Power Levels	Frequency (Hz)								Casing Radiated			
		63	125	250	500	1k	2k	4k	8k	NR@1m	NR@3m	dBA@1m	dBA@3m
100%	Casing Radiated	70	70	55	48	39	37	35	30	37	30	39	33
	Intake	56	67	61	59	57	55	51	43				
	Outlet	75	62	53	50	54	50	41	25				
80%	Casing Radiated	69	68	54	44	37	35	32	29	35	27	37	31
	Intake	56	65	59	57	55	52	49	40				
	Outlet	72	58	50	47	51	47	37	21				
60%	Casing Radiated	66	64	54	37	34	31	29	27	31	23	35	28
	Intake	50	62	56	54	51	48	44	33				
	Outlet	64	54	47	44	48	43	32	15				
40%	Casing Radiated	60	57	50	36	27	26	26	27	25	18	29	23
	Intake	46	56	49	49	45	41	34	21				
	Outlet	52	48	41	39	41	35	23	4				

Sound Spectrum dB re 10⁻¹² W pWL. Units are independently tested at ISVR in accordance with BS EN ISO 3744:2010

Unit dimensions

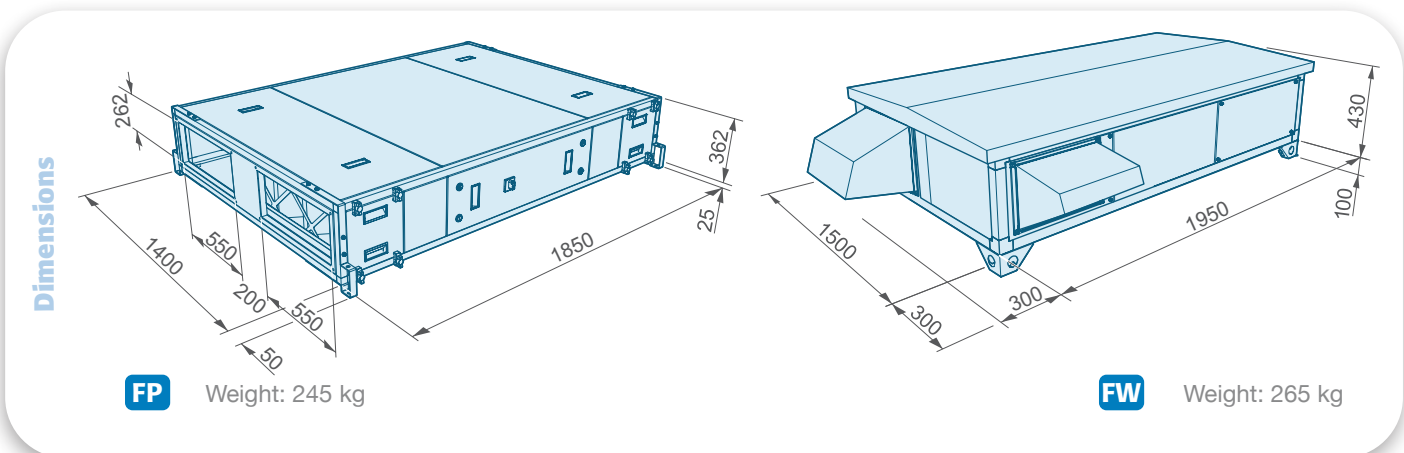

LPHW Heating data

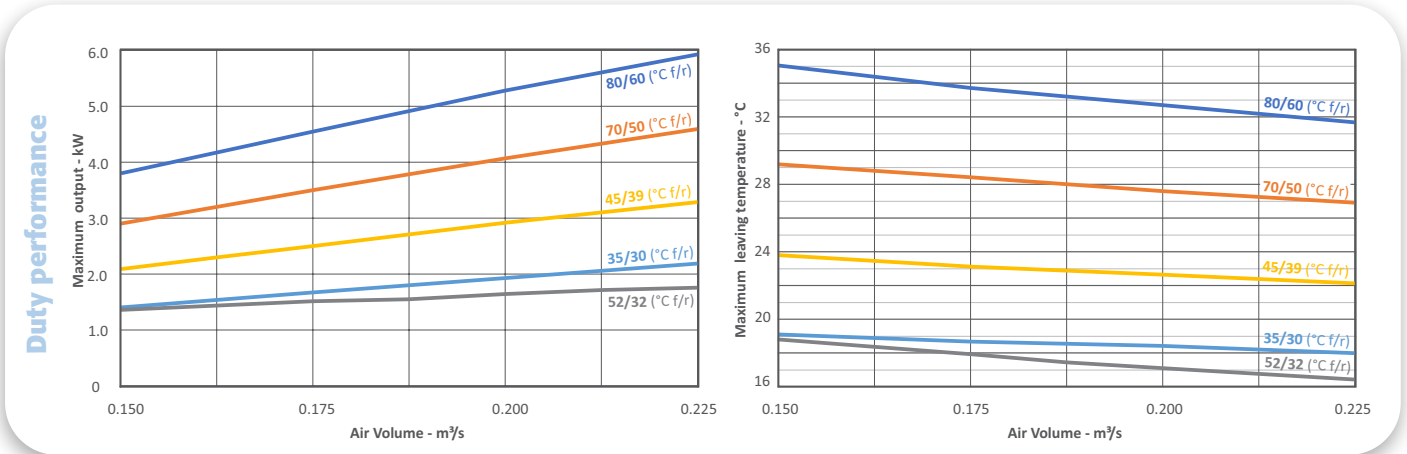

EVCBCL1010	Flow/Return °C	Air Volume m³/s	Max Leaving Temperature °C	Max Output kW	Water Flow Rate l/s	Water Pressure Drop kPa	Air Pressure Drop Pa
	80/60	0.175	33.2	4.9	0.060	3.0	13
		0.200	32.4	5.4	0.066	3.0	16
		0.225	31.7	5.9	0.072	3.0	20
	70/50	0.175	28.0	3.8	0.046	3.0	12
		0.200	27.4	4.2	0.051	3.0	16
		0.225	26.8	4.6	0.056	3.0	20

EVCBCL1010	Flow/Return °C	Air Volume m³/s	Max Leaving Temperature °C	Max Output kW	Water Flow Rate l/s	Water Pressure Drop kPa	Air Pressure Drop Pa
	52/32	0.175	17.5	1.6	0.019	3.0	12
		0.200	17.0	1.7	0.021	3.0	15
		0.225	16.5	1.8	0.022	3.0	19
	45/39	0.175	22.9	2.7	0.110	3.0	12
		0.200	22.5	3.0	0.121	3.0	16
		0.225	22.1	3.3	0.132	3.0	19
	35/30	0.175	18.6	1.8	0.087	3.0	12
		0.200	18.3	2.0	0.097	3.0	15
0.225		18.0	2.2	0.105	3.0	19	

Air off temperature based upon 10 °C taken after the heat exchanger (approximately entering air FAT -5 °C, RAT 12 °C)
Coil construction copper tubes, aluminium fins, coil connections 1" BSP.

UNIT EVCB174-1

EHB Heating data

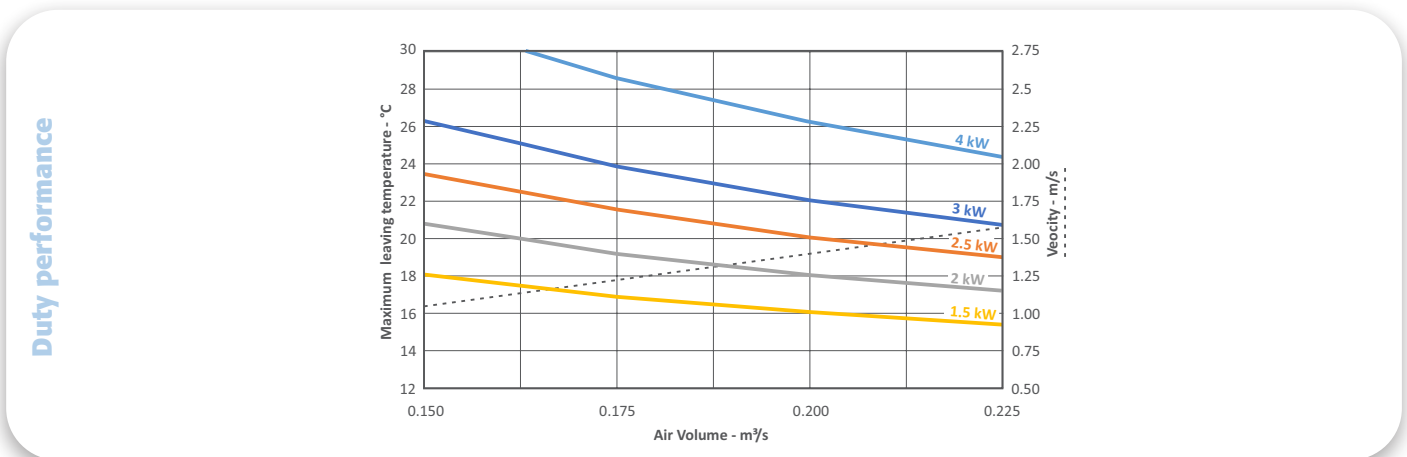

Air Volume m³/s	Maximum Leaving Air Temp °C	Maximum kW Output	1ph - Electric Heater	3ph - Electric Heater
0.175	23.9	3.0	EHEVC1/3KW/1X1	n/a
0.2	22.2	3.0	EHEVC1/3KW/1X1	
0.225	24.5	4.0	EHEVC1/4KW/1X1	

Air off temperature based upon 10 °C taken after the heat exchanger (approximately entering air FAT -5 °C, RAT 12 °C)
Power = Air Volume x Constant x Temperature Rise. kW = m³/s x 1.21 x ΔT °C.
Note: If no control panel is purchased the unit will be supplied with a main isolator.

Note: Data for design guidance only. Detailed information is available upon request.

Selection data

ecovent EVCB262-1

Performance

$$\text{SFP} = \frac{\text{Electrical input power (Watts)}}{\text{Air volume flow rate (litres/second)}}$$

Note: SFP figures quoted at voltages tested in accordance with BS EN ISO 5801:2017 for each of the two fans.

Tolerances:
 On flow rates: +/- 5%
 On acoustic power and pressure: Levels: +/- 3 dB
 By octave band: +/- 5 dB

Heat exchanger efficiency is calculated based upon EAT -5 °C and RAT +20 °C.
 The fan performance is calculated using standard G4 filters (BS EN ISO 16890 Coarse 65%).

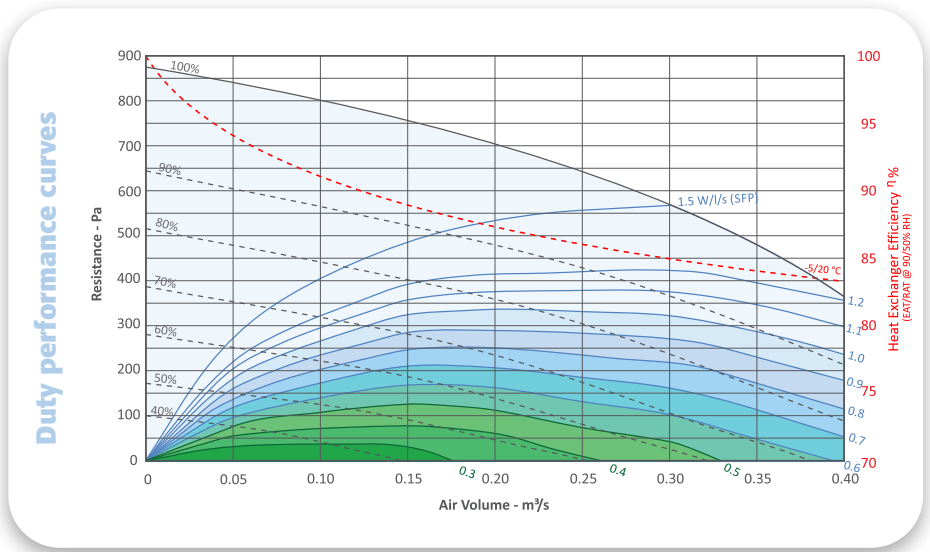

Size	Phase	Motor Size	Voltage	Fan Speed	Motor Full Load Current	Speed Control
EVCB262-1	1 Phase	0.500 kW	230 VAC	3080 rpm	2.5 A	EC

Acoustic data

Fan Speed	Sound Power Levels	Frequency (Hz)								Casing Radiated			
		63	125	250	500	1k	2k	4k	8k	NR@1m	NR@3m	dBA@1m	dBA@3m
100%	Casing Radiated	76	70	61	61	52	51	45	41	42	35	45	39
	Intake	63	67	74	76	70	65	63	59				
	Outlet	77	62	67	68	64	59	47	35				
80%	Casing Radiated	71	65	62	47	46	46	40	35	37	30	40	34
	Intake	57	64	72	67	64	59	57	53				
	Outlet	69	61	69	61	58	54	42	28				
60%	Casing Radiated	68	62	56	43	43	42	36	32	30	23	36	29
	Intake	51	62	72	60	56	51	47	44				
	Outlet	56	50	59	51	49	45	33	19				
40%	Casing Radiated	55	57	38	30	30	29	27	27	22	15	26	20
	Intake	28	63	52	47	45	38	37	28				
	Outlet	36	50	43	40	39	35	20	5				

Sound Spectrum dB re 10⁻¹² W pWL. Units are independently tested at ISVR in accordance with BS EN ISO 3744:2010

Unit dimensions

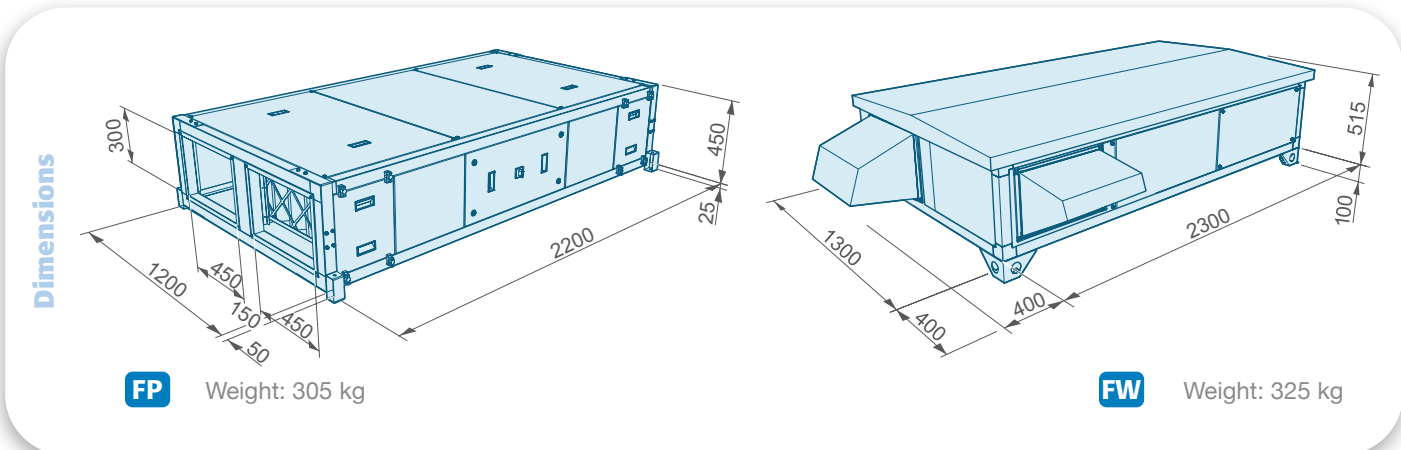

FP Weight: 305 kg

FW Weight: 325 kg

LPHW Heating data

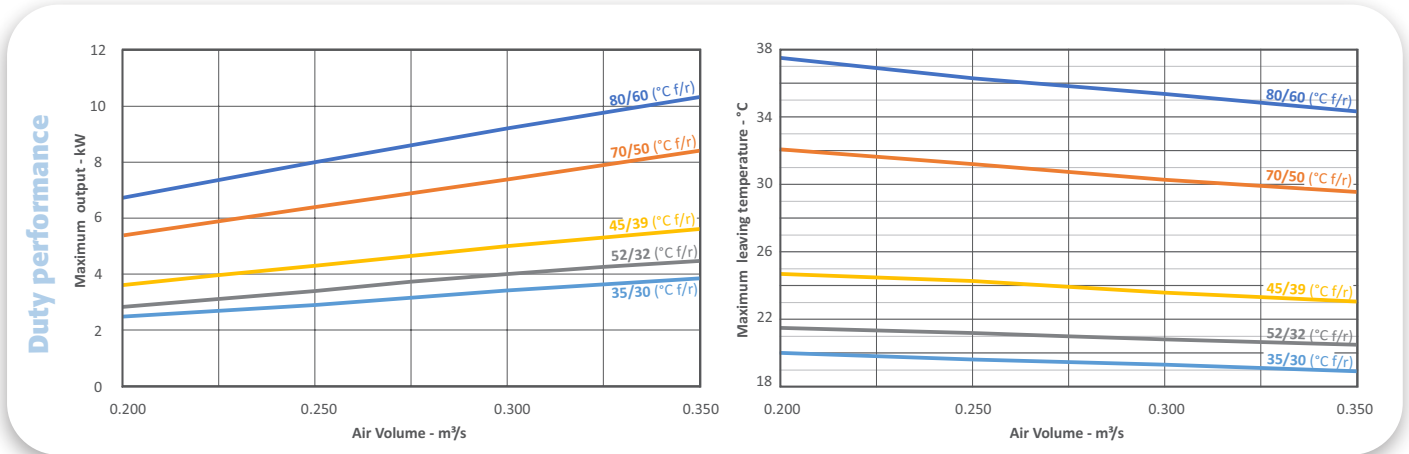

EVCBCL1020	Flow/Return °C	Air Volume m³/s	Max Leaving Temperature °C	Max Output kW	Water Flow Rate l/s	Water Pressure Drop kPa	Air Pressure Drop Pa
	80/60	0.25	36.4	8.0	0.098	3.0	9
		0.30	35.4	9.2	0.113	3.0	12
		0.35	34.4	10.3	0.126	3.5	16
	70/50	0.25	31.2	6.4	0.078	3.0	9
		0.30	30.4	7.4	0.090	3.0	12
		0.35	29.6	8.3	0.101	3.0	16

EVCBCL1020	Flow/Return °C	Air Volume m³/s	Max Leaving Temperature °C	Max Output kW	Water Flow Rate l/s	Water Pressure Drop kPa	Air Pressure Drop Pa
	52/32	0.25	21.3	3.4	0.041	3.0	9
		0.30	21.0	4.0	0.048	3.0	12
		0.35	20.6	4.5	0.054	3.0	16
	45/39	0.25	24.3	4.3	0.174	6.7	9
		0.30	23.7	5.0	0.201	8.7	12
		0.35	23.2	5.6	0.226	10.8	16
	35/30	0.25	19.7	3.0	0.142	4.8	9
		0.30	19.4	3.4	0.164	6.2	12
		0.35	19.0	3.8	0.184	7.7	16

Air off temperature based upon 10 °C taken after the heat exchanger (approximately entering air FAT -5 °C, RAT 12 °C)
Coil construction copper tubes, aluminium fins, coil connections 1" BSP.

UNIT EVCB262-1

EHB Heating data

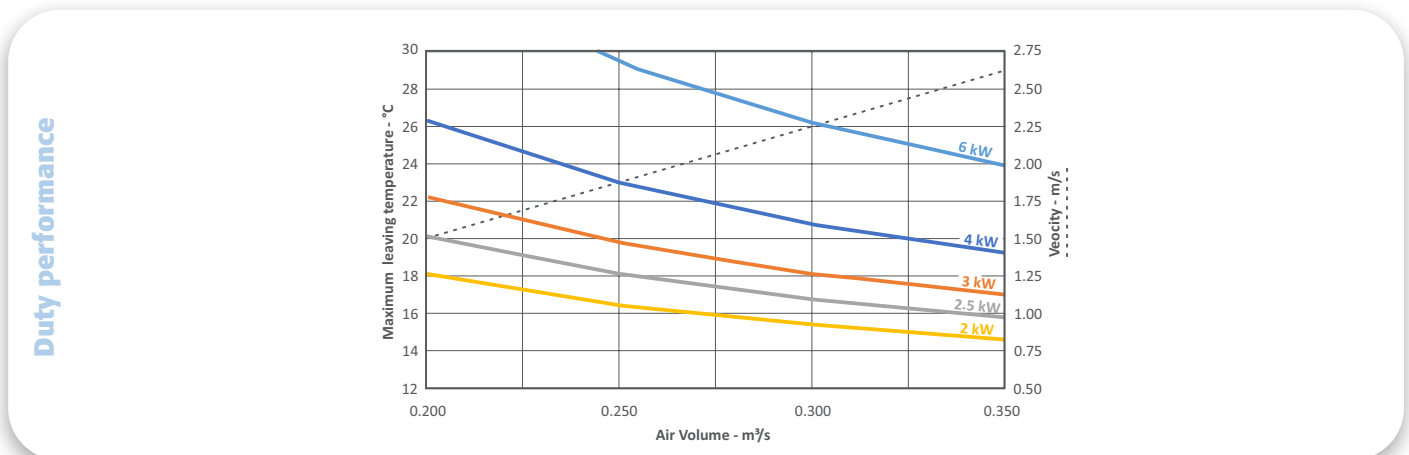

Air Volume m³/s	Maximum Leaving Air Temp °C	Maximum kW Output	1ph - Electric Heater	3ph - Electric Heater
0.25	23.0	4.0	EHEVC2/4KW/1X1	EHEVC2/4KW/1X3
0.30	26.3	6.0	EHEVC2/6KW/1X1	EHEVC2/6KW/1X3
0.35	23.9	6.0	EHEVC2/6KW/1X1	EHEVC2/6KW/1X3

Air off temperature based upon 10 °C taken after the heat exchanger (approximately entering air FAT -5 °C, RAT 12 °C)
Power = Air Volume x Constant x Temperature Rise. kW = m³/s x 1.21 x ΔT °C.
Note: If no control panel is purchased the unit will be supplied with a main isolator.

Note: Data for design guidance only. Detailed information is available upon request.

Selection data

ecovent EVCB385-1

Performance

$$\text{SFP} = \frac{\text{Electrical input power (Watts)}}{\text{Air volume flow rate (litres/second)}}$$

Note: SFP figures quoted at voltages tested in accordance with BS EN ISO 5801:2017 for each of the two fans.

Tolerances:
 On flow rates: +/- 5%
 On acoustic power and pressure: Levels: +/- 3 dB
 By octave band: +/- 5 dB

Heat exchanger efficiency is calculated based upon EAT -5 °C and RAT +20 °C.
 The fan performance is calculated using standard G4 filters (BS EN ISO 16890 Coarse 65%).

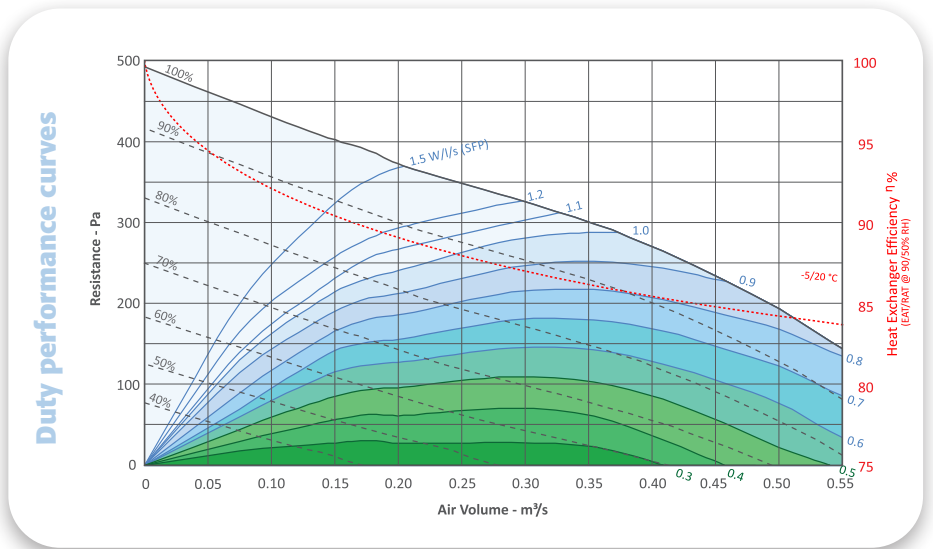

Size	Phase	Motor Size	Voltage	Fan Speed	Motor Full Load Current	Speed Control
EVCB385-1	1 Phase	0.560 kW	230 VAC	2100 rpm	2.80 A	EC

Acoustic data

Fan Speed	Sound Power Levels	Frequency (Hz)								Casing Radiated			
		63	125	250	500	1k	2k	4k	8k	NR@1m	NR@3m	dBA@1m	dBA@3m
100%	Casing Radiated	74	71	64	53	51	52	46	40	39	33	44	38
	Intake	49	66	73	67	64	63	59	51				
	Outlet	67	60	67	61	61	58	46	31				
80%	Casing Radiated	70	66	62	49	46	46	39	33	36	30	40	34
	Intake	53	65	69	62	58	58	54	44				
	Outlet	60	57	61	57	55	52	39	23				
60%	Casing Radiated	63	63	49	41	38	38	32	28	29	22	33	27
	Intake	49	66	60	55	51	50	45	35				
	Outlet	50	59	52	49	48	44	30	11				
40%	Casing Radiated	58	62	40	32	30	28	27	28	27	20	30	24
	Intake	49	55	49	43	39	36	31	18				
	Outlet	43	44	40	37	36	31	18	2				

Sound Spectrum dB re 10⁻¹² W pWL. Units are independently tested at ISVR in accordance with BS EN ISO 3744:2010

Unit dimensions

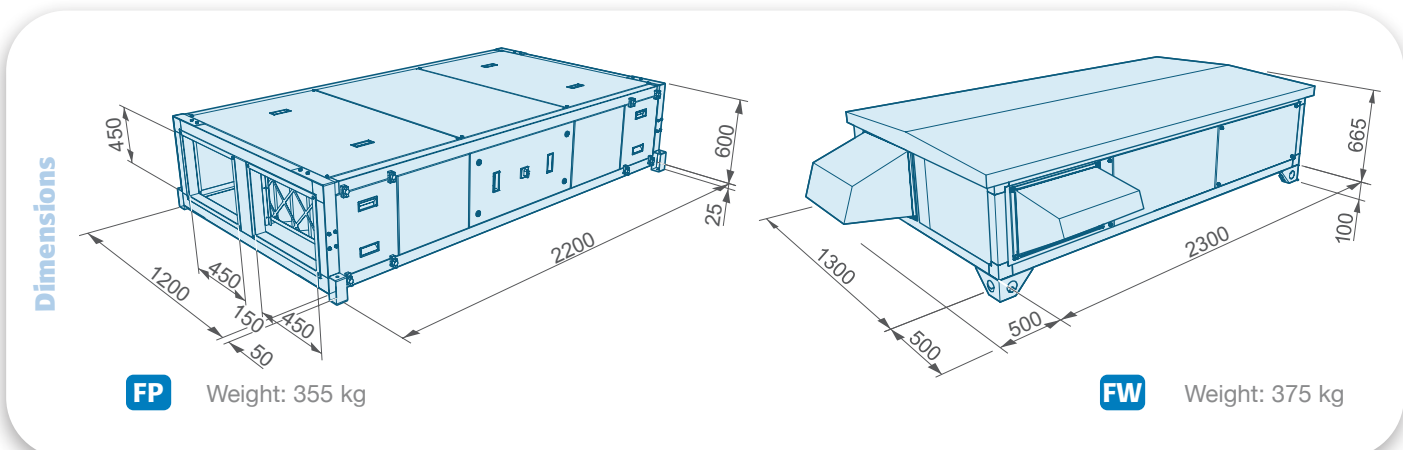

LPHW Heating data

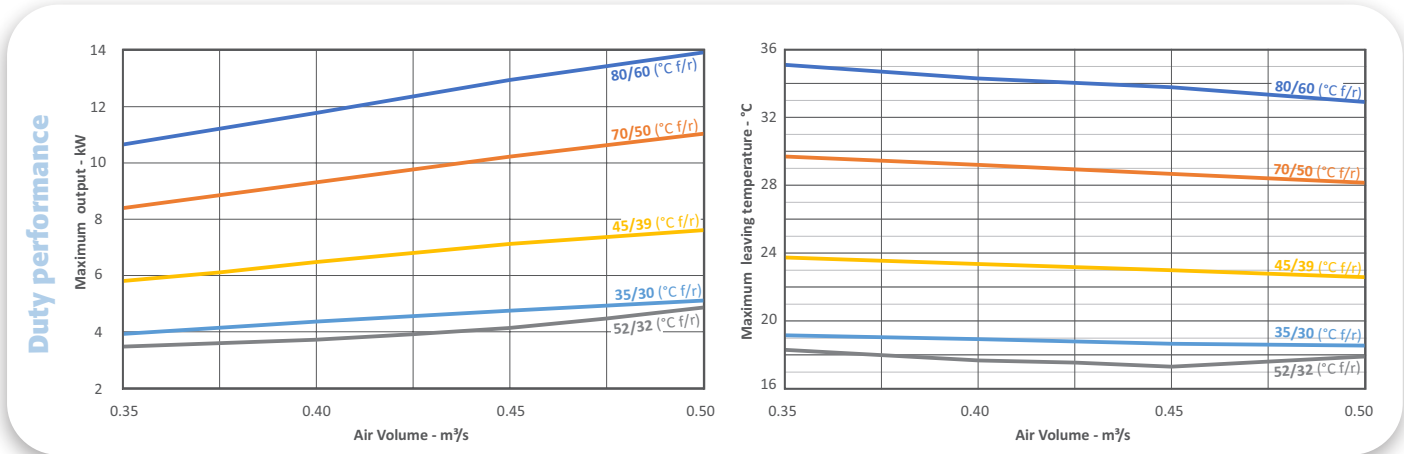

EVCBCL1030	Flow/Return °C	Air Volume m³/s	Max Leaving Temperature °C	Max Output kW	Water Flow Rate l/s	Water Pressure Drop kPa	Air Pressure Drop Pa
	80/60	0.40	34.5	11.9	0.145	3.0	11
		0.45	33.8	13.0	0.158	3.0	14
		0.50	33.1	14.0	0.171	3.0	17
	70/50	0.40	29.3	9.4	0.114	3.0	11
		0.45	28.8	10.2	0.124	3.0	14
		0.50	28.2	11.1	0.134	3.0	16

EVCBCL1030	Flow/Return °C	Air Volume m³/s	Max Leaving Temperature °C	Max Output kW	Water Flow Rate l/s	Water Pressure Drop kPa	Air Pressure Drop Pa
	52/32	0.40	17.8	3.8	0.046	3.0	11
		0.45	17.4	4.2	0.049	3.0	13
		0.50	18.0	4.8	0.058	3.0	16
	45/39	0.40	23.4	6.5	0.261	3.6	11
		0.45	23.0	7.1	0.286	4.2	13
		0.50	22.7	7.7	0.310	4.8	16
	35/30	0.40	19.0	4.4	0.211	3.0	11
		0.45	18.8	4.8	0.231	3.0	13
		0.50	18.6	5.2	0.250	3.4	16

Air off temperature based upon 10 °C taken after the heat exchanger (approximately entering air FAT -5 °C, RAT 12 °C)
Coil construction copper tubes, aluminium fins, coil connections 1" BSP.

UNIT EVCB385-1

EHB Heating data

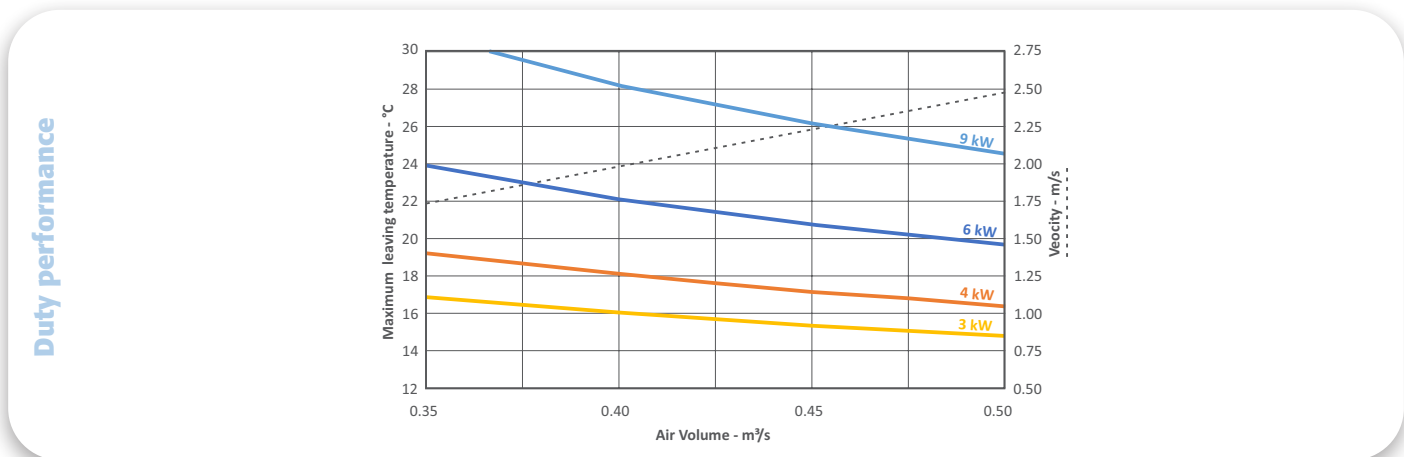

Air Volume m³/s	Maximum Leaving Air Temp °C	Maximum kW Output	1ph - Electric Heater	3ph - Electric Heater
0.40	22.2	6.0	EHEVC3/6KW/1X1	EHEVC3/6KW/1X3
0.45	26.3	9.0	EHEVC3/9KW/1X1	EHEVC3/9KW/1X3
0.50	24.6	9.0	EHEVC3/9KW/1X1	EHEVC3/9KW/1X3

Air off temperature based upon 10 °C taken after the heat exchanger (approximately entering air FAT -5 °C, RAT 12 °C)
Power = Air Volume x Constant x Temperature Rise. kW = m³/s x 1.21 x ΔT °C.
Note: If no control panel is purchased the unit will be supplied with a main isolator.

Note: Data for design guidance only. Detailed information is available upon request.

Selection data

ecovent EVCB485-1

Performance

$$\text{SFP} = \frac{\text{Electrical input power (Watts)}}{\text{Air volume flow rate (litres/second)}}$$

Note: SFP figures quoted at voltages tested in accordance with BS EN ISO 5801:2017 for each of the two fans.

Tolerances:
 On flow rates: +/- 5%
 On acoustic power and pressure: Levels: +/- 3 dB
 By octave band: +/- 5 dB

Heat exchanger efficiency is calculated based upon EAT -5 °C and RAT +20 °C.
 The fan performance is calculated using standard G4 filters (BS EN ISO 16890 Coarse 65%).

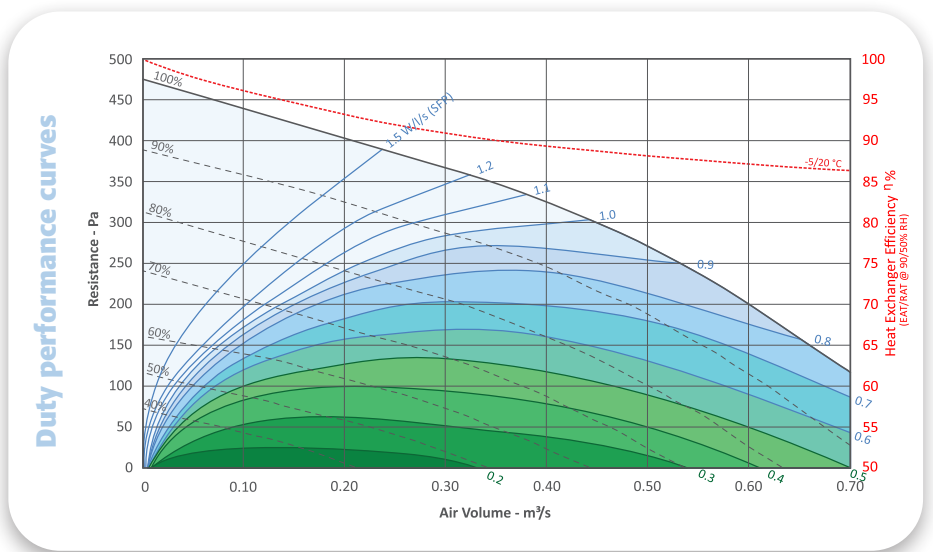

Size	Phase	Motor Size	Voltage	Fan Speed	Motor Full Load Current	Speed Control
EVCB485-1	1 Phase	0.560 kW	230 VAC	2100 rpm	2.80 A	EC

Acoustic data

Fan Speed	Sound Power Levels	Frequency (Hz)								Casing Radiated			
		63	125	250	500	1k	2k	4k	8k	NR@1m	NR@3m	dBA@1m	dBA@3m
100%	Casing Radiated	68	65	63	52	53	54	48	40	41	35	44	38
	Intake	49	66	73	67	64	63	59	51				
	Outlet	67	60	67	61	61	58	46	31				
80%	Casing Radiated	63	62	60	50	48	48	42	35	36	29	40	33
	Intake	53	65	69	62	58	58	54	44				
	Outlet	60	57	61	57	55	52	39	23				
60%	Casing Radiated	56	60	48	41	40	40	34	30	28	21	32	26
	Intake	49	66	60	55	51	50	45	35				
	Outlet	50	59	52	49	48	44	30	11				
40%	Casing Radiated	52	58	41	31	31	30	28	29	23	15	27	21
	Intake	49	55	49	43	39	36	31	18				
	Outlet	43	44	40	37	36	31	18	2				

Sound Spectrum dB re 10⁻¹² W pWL. Units are independently tested at ISVR in accordance with BS EN ISO 3744:2010

Unit dimensions

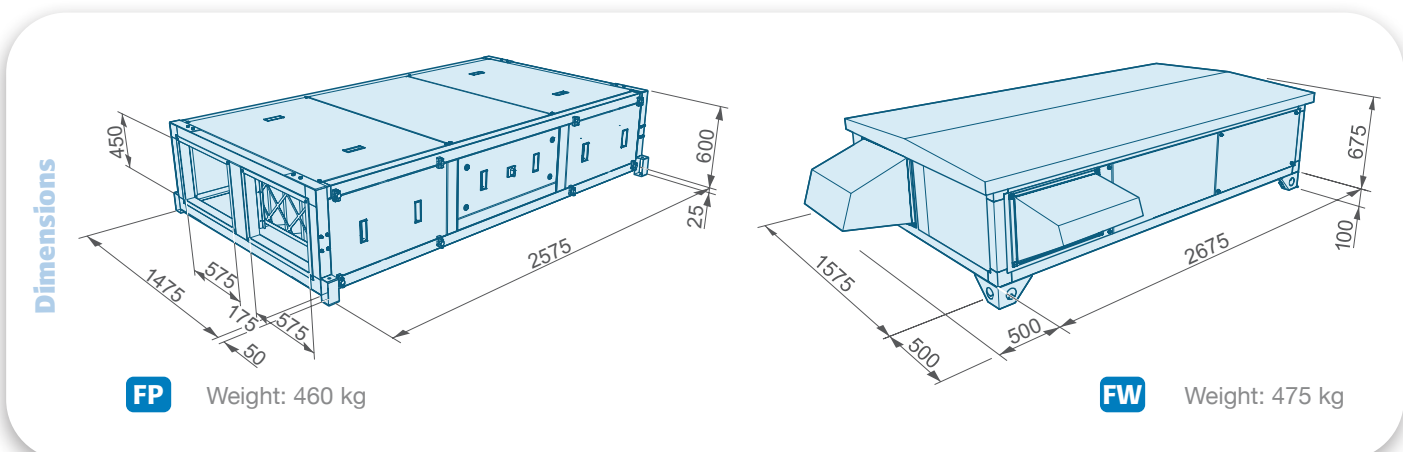

Note: Data for design guidance only. Detailed information is available upon request.

LPHW Heating data

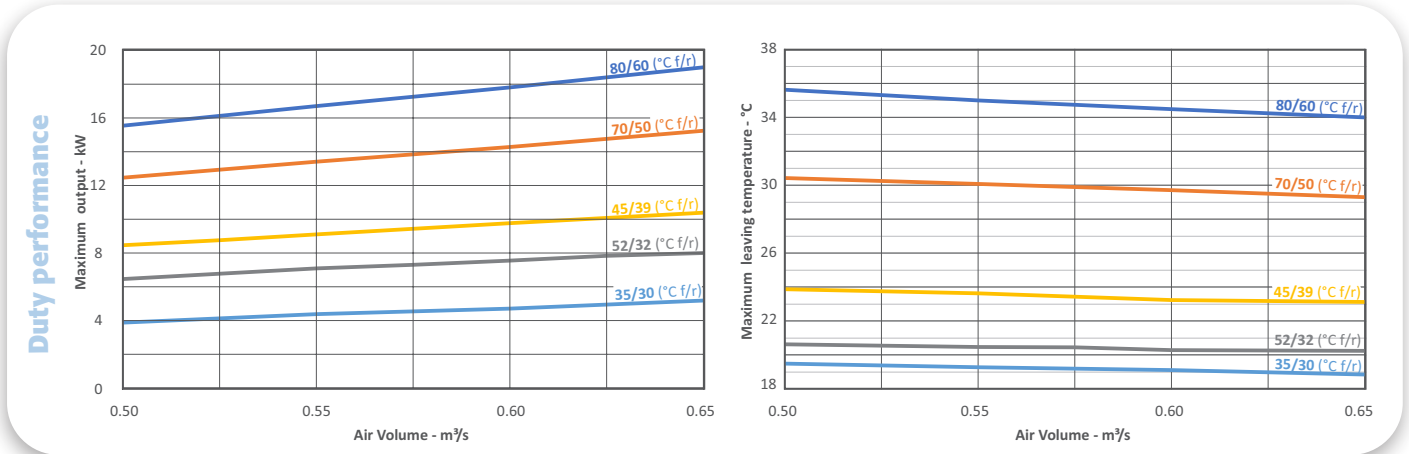

EVCBCL1040	Flow/Return °C	Air Volume m³/s	Max Leaving Temperature °C	Max Output kW	Water Flow Rate l/s	Water Pressure Drop kPa	Air Pressure Drop Pa
	80/60	0.55	35.1	16.7	0.204	3.0	12
		0.60	34.6	17.9	0.218	3.0	14
		0.65	34.0	18.9	0.231	3.0	17
	70/50	0.55	30.1	13.4	0.163	3.0	12
		0.60	29.7	14.3	0.174	3.0	14
		0.65	29.3	15.2	0.184	3.0	16

EVCBCL1040	Flow/Return °C	Air Volume m³/s	Max Leaving Temperature °C	Max Output kW	Water Flow Rate l/s	Water Pressure Drop kPa	Air Pressure Drop Pa
	52/32	0.55	20.5	7.0	0.084	3.0	12
		0.60	20.3	7.5	0.091	3.0	14
		0.65	20.2	8.0	0.097	3.0	16
	45/39	0.55	23.6	9.1	0.365	6.4	12
		0.60	23.3	9.7	0.390	7.2	14
		0.65	23.1	10.3	0.414	8.0	16
	35/30	0.55	19.3	6.2	0.298	4.6	12
		0.60	19.1	6.6	0.318	5.1	14
		0.65	18.9	7.0	0.338	5.7	16

Air off temperature based upon 10 °C taken after the heat exchanger (approximately entering air FAT -5 °C, RAT 12 °C)
Coil construction copper tubes, aluminium fins, coil connections 1 1/4" BSP.

UNIT EVCB485-1

EHB Heating data

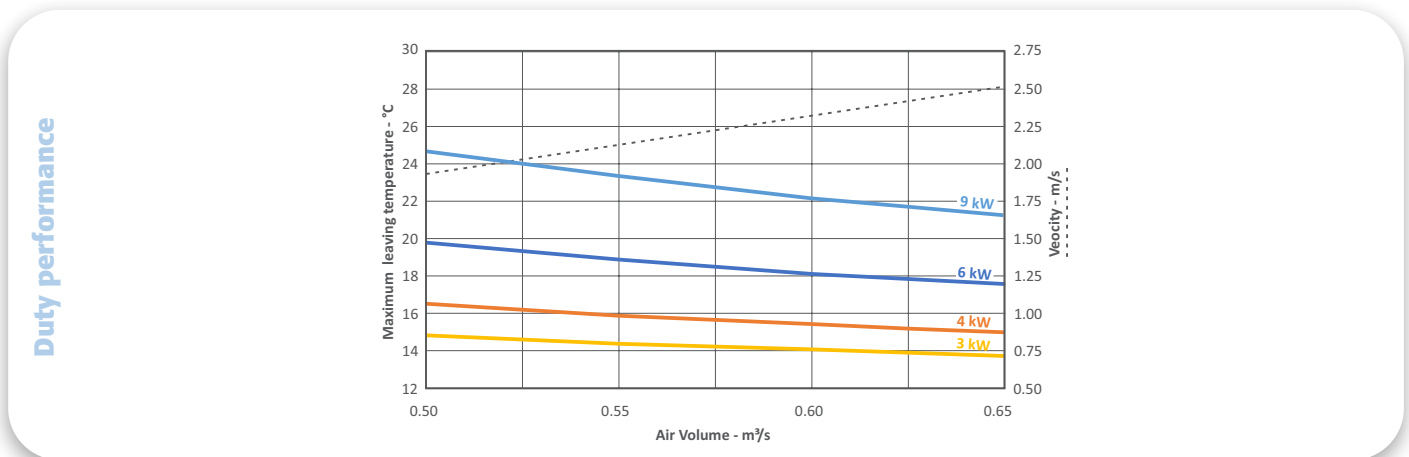

Air Volume m³/s	Maximum Leaving Air Temp °C	Maximum kW Output	1ph - Electric Heater	3ph - Electric Heater
0.55	23.3	9.0	EHEVC4/9KW/1X1	EHEVC4/9KW/1X3
0.60	22.2	9.0	EHEVC4/9KW/1X1	EHEVC4/9KW/1X3
0.65	21.3	9.0	EHEVC4/9KW/1X1	EHEVC4/9KW/1X3

Air off temperature based upon 10 °C taken after the heat exchanger (approximately entering air FAT -5 °C, RAT 12 °C)
Power = Air Volume x Constant x Temperature Rise. kW = m³/s x 1.21 x ΔT °C.
Note: If no control panel is purchased the unit will be supplied with a main isolator.

Note: Data for design guidance only. Detailed information is available upon request.

Control packages for performance and efficiency



Save energy and costs with BlueSense Controls

Demand ventilation solutions













BlueSense philosophy combines intelligent control technologies with energy saving products, services and engineering expertise. BlueSense helps meet energy reduction commitments by optimising equipment performance, improving energy efficiency, saving money and increasing equipment life expectancy.

BlueSense can be applied to a variety of projects and applications, providing efficient solutions whilst supporting design for best practice and sustainability.



BlueSense Features

- ▶ Inbuilt intelligent controls technology
- ▶ Optimises performance and efficiency
- ▶ Demand ventilation control improves air quality, reducing energy consumption and lowering operating costs
- ▶ Combined CO₂ and VOC sensing technology with energy efficient speed control
- ▶ Extending equipment life expectancy and reducing maintenance
- ▶ Short term payback on capital expenditure
- ▶ Extended warranty

 Prewired/Fitted Controls	 Demand Ventilation	 Case Construction	 Filters	 Air Quality	 Thyristor Heater
 Energy Efficient Fans	 Speed Control	 Plug & Play	 Humidity	 Temperature	 Heat Recovery

ecovent counterflow BlueSense

All products in the **ecovent** range can form part of a BlueSense energy saving package. Specify BlueSense to ensure units are optimised with pre-wired controls, energy efficient speed controller and air quality sensor. All of these work in unison, reducing energy consumption and saving money.

A BlueSense Example

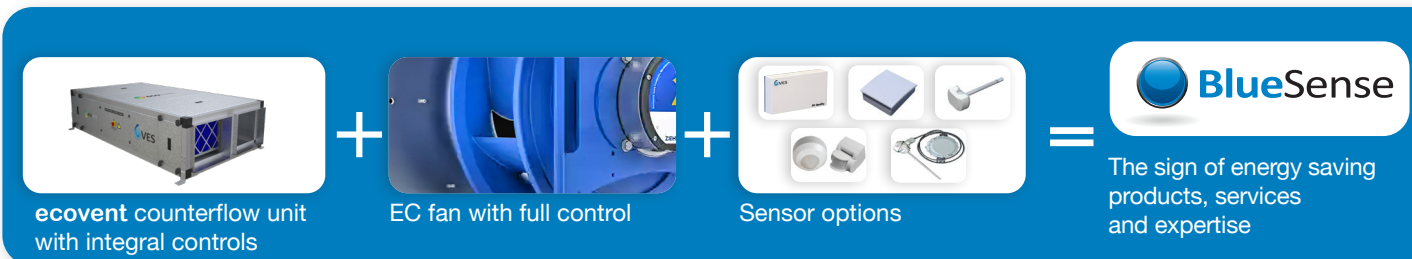



ecovent[®] counterflow Controls - Extended Features CPB & CPC Range

The **ecovent** counterflow unit with integrated controls is specifically designed for use in heat recovery applications. The CPB control system can be supplied fully integrated into an **ecovent** counterflow air handling unit to reduce installation time and costs. The CPB and CPC control systems can be supplied as a loose panel for installation by others.

Features

- Designed, manufactured and supported by VES engineers
- Default settings for “out of the box” operation and to minimise commissioning time
- Versatile user interface and open protocol integration option
- Door isolator and easily identified field terminals to assist installation and maintenance
- Extensive parameter adjustment to optimise installation and further improve system efficiency
- Energy monitoring providing real time energy consumption and heat exchanger efficiency information

Specification for CPB & CPC Control Panels for Heat Recovery Applications

Features	CPB	CPC
Fitted and pre-wired within Ecovent or traditional loose panel options	✓	✓
Supply fan starter with speed control interlock	✓	✓
Extract fan starter with speed control interlock	✓	✓
Heat recovery damper modulation, free heating and cooling optimisation	✓	✓
Mixing box or heatwheel modulation		✓
Heating, modulating control	✓	✓
Frost protection and heating demand output for water coils	✓	✓
Temperature philosophy; supply, return or return + supply limits	✓	✓
7 day time clock	✓	✓
Demand ventilation; Air Quality, constant pressure or volume	✓	✓
Filter dirty indication; inputs for DP switches	✓	✓
Fan run-on and safety interlocks	✓	✓
Remote start / stop via removable link	✓	✓
Common trip indication	✓	✓
Fire alarm shutdown, 24 VDC	✓	✓
Inlet and return damper	✓	✓
DX heat pump and cooling		✓
Remote user interface, full function	✓	✓
Remote user interface, limited function	○	○
Facia mounted user interface (replaces remote user interface)	○	○
Remote user interface, full function touch screen		○
Energy monitoring with real time display		○
Heat recovery efficiency with real time display		✓
Integration by Modbus over RS485 open protocol or ethernet BACnet MS/TP	○	○
Integration by BACnet/IP open protocol	○	○
Bespoke to suit requirement		○
BlueSense - Energy Saving Package	✓	✓
Energy efficient speed control	✓	✓
Demand Control	✓	✓
Post installation Commissioning	○	○

○ = Option



BlueSense includes an Extended Warranty

- 3 years with BlueSense packages
- 5 years with BlueSense package and Post Installation Commissioning

Please quote BlueSense with your order or contact our specialist sales team for further information. Call +44 (0)23 8046 1150 or email sales@ves.co.uk

ecovent® silencers

Performance

Notes:
Single skinned silencers are required for each individual spigot connection. Double skinned silencers are paired (see below) designed to match the corresponding unit casework.

Tolerances:
On flow rates: +/- 5%
On acoustic power and pressure: Levels: +/- 3 dB
By octave band: +/- 5 dB

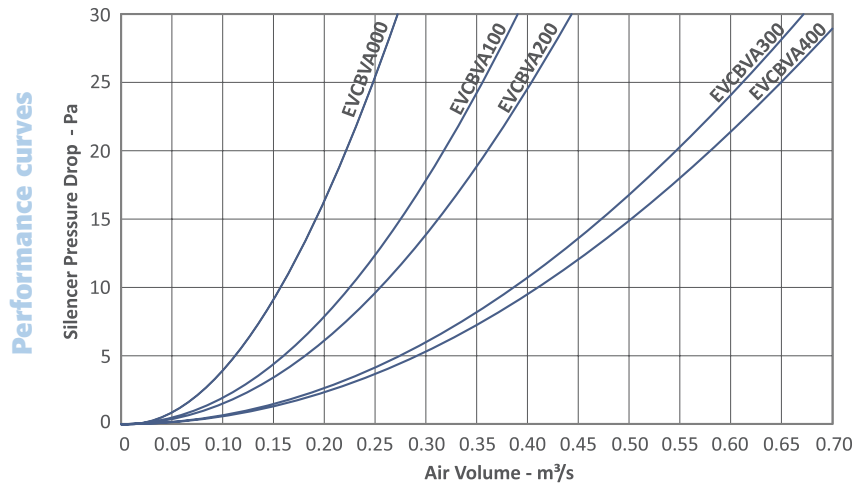

Unit dimensions

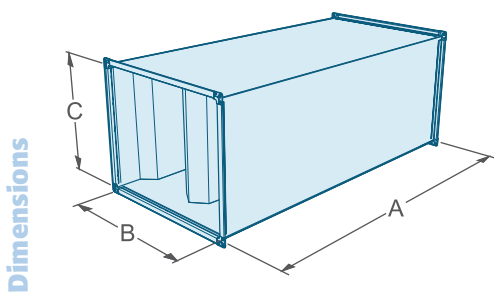

EVCBVA---/ SS (single skinned)

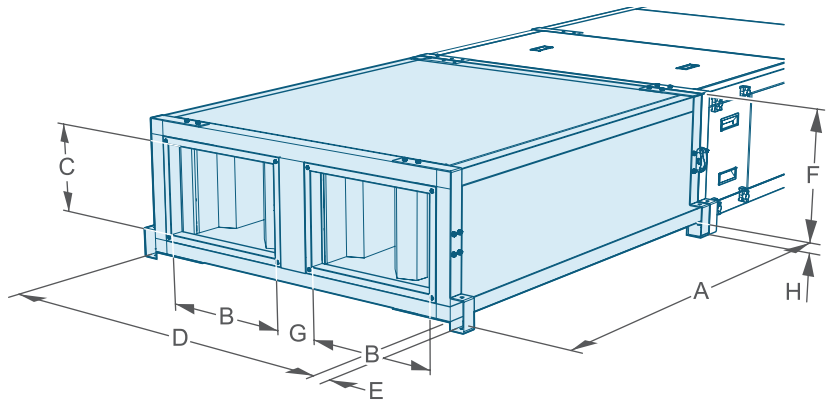

EVCBVA---/ DS (double skinned 25mm)

EE (double skinned 50mm)

Single skinned Silencers	Dimensions mm			Weight kg	Double skinned Silencers	Dimensions mm								Weight kg
	A	B	C			A	B	C	D	E	F	G	H	
EVCBVA000/SS/1200	1200	450	180	14	EVCBVA000/DS/1200	1200	450	180	1200	50	280	200	25	85
EVCBVA100/SS/1200	1200	550	262	23	EVCBVA100/DS/1200	1200	550	262	1400	50	362	200	25	115
EVCBVA200/SS/1200	1200	450	300	26	EVCBVA200/EE/1200	1200	450	300	1200	50	450	150	25	130
EVCBVA300/SS/1200	1200	450	450	33	EVCBVA300/EE/1200	1200	450	450	1200	50	600	150	25	145
EVCBVA400/SS/1200	1200	575	450	36	EVCBVA400/EE/1200	1200	575	450	1475	50	600	175	25	155

Acoustic Data

Silencer Induct Losses		Frequency (Hz)							
		63	125	250	500	1k	2k	4k	8k
EVCBVA.../1200	Standard 1200 mm airway	-6	-11	-18	-22	-25	-17	-22	-20
EVCBVA.../900	Non-standard 900 mm airway	-5	-9	-16	-30	-39	-39	-31	-26
EVCBVA.../1500	Non-standard 1500 mm airway	-8	-15	-26	-43	-53	-53	-45	-32

Sound Spectrum dB re 10⁻¹² W PWL. Units are independently tested at ISVR in accordance with BS EN ISO 3741:2010.

Note: Data for design guidance only. Detailed information is available upon request.



Bespoke Solutions

As well as offering a wide range of standard Ecovent units VES are able to build bespoke versions for special applications and requirements.

Units can be adapted for higher specifications to address challenging locations and applications. Our experience with controls also enables high levels of integration with Building Management Systems or existing solutions, as well as matching to niche applications.

With VES you really get the full package without needing to mix and match suppliers.



Bespoke Options

- ▶ Acoustic options for noise sensitive applications
- ▶ EC Plug fans for duties above 1.3 m³/s
- ▶ Controls integration into new and existing building management systems
- ▶ Aesthetic requirements and paint colour finishes
- ▶ Saline environment protection
- ▶ Cooling coils
- ▶ Specialist filtration applications i.e carbon, grease, HEPA
- ▶ Flatpack and site assistance

Specialist Site Services

VES operates a Specialist Site Services division, which is a market leader in the repair and refurbishment of any make or model of air handling equipment.

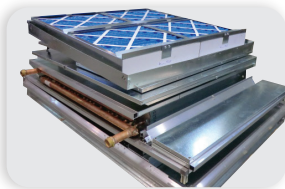

Flatpacking

- ▶ To suit difficult access locations
- ▶ Saves craneage costs
- ▶ No need for road closures
- ▶ Reduced manual handling risks



Post Installation Commissioning

VES technical engineers can ensure the unit has been installed and set up correctly. Also, VES can check all control wiring, set the unit running and measure air volumes (if suitable traverse point is available).



Spares and Maintenance

VES holds stock, or can source parts for all VES and other manufacturers products. A reminder service and regular user discount are available. VES offers varied maintenance agreements to suit location and budget.



Energy Saving Solutions for Kitchens

VES can manufacture special Ecovent-K's, complete with grease filters, designed specifically for kitchens.



Ecovent-K

Site Assistance By Specialist Site Services

VES has an accomplished Site Services division. Ecovent units can be delivered in flat pack form and re-assembled "in situ" in restricted and difficult locations.

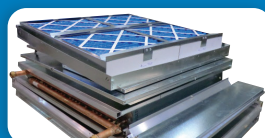

Flat Pack



Crane Lifts



Site Assistance

Product Specification

ecovent® counterflow Premium Efficiency (EVCB) Heat Recovery Units

1.1. General

- A. Provide a heat recovery air handling unit to meet the performance and configuration as indicated in the schedule and detail drawings. The heat recovery air handling unit shall be tested to BS EN ISO 5801:2017 and shall be of the Ecovent type as manufactured by VES Andover Ltd, a company accredited with BS EN ISO 9001:2015.

1.2. Unit Construction

- A. The unit shall be provided pre-assembled comprising a rigidly constructed aluminium case, double skinned galvanised sheet steel panels, supply and extract centrifugal fans with direct drive motor, supply and extract G4 pleated panel filters, and plate heat exchanger with drain pan.
- B. The construction shall be tested by BSRIA in accordance with BS EN 1886:2007.
- C. The unit shall be supplied in one section.
- D. The unit shall be available with optional fitted electric or hot water heating as indicated in the schedule and detail drawings.
- E. The unit shall be available in plantroom or weatherproof construction as indicated in the schedule and detail drawings.
- F. The unit shall be fitted with a heat exchanger bypass duct, incorporating a face and bypass damper to allow heating / cooling recovery and free heating / cooling.
- G. The unit shall have rectangular connections compatible with 20 mm Mez flange connections as indicated in the schedule and detail drawings.
- H. The unit casework shall incorporate high quality rubber gasket seals on service doors and panels.
- I. Access for maintenance shall be via a removable lid or panels, allowing access for the cleaning or removal of internal components as indicated in the detail drawings. The filters shall be side withdrawal as standard. Top / bottom filter access may also be available.
- J. Flat plantroom casework shall incorporate mounting brackets compatible with drop-rod systems.
- K. The unit shall be compatible with optional self-levelling feet as provided by VES Andover Ltd.
- L. The unit shall be supplied in the configuration: flat, plantroom/weatherproof. Access and handing options shall be as indicated in the schedule and detail drawings.

1.3. Fans

- A. The fan impellers shall be statically and dynamically balanced to G 2.5 / G 6.3 according to ISO 21940-11:2016.
- B. The fan impellers shall be mated with aerodynamic bell inlet eyes for high efficiency and low noise generation.
- C. The fan impellers shall be supplied in natural uncoated finish as standard.

1.4. Motors

- A. The fans shall incorporate external rotor motors to insulation class F, IP4X environmental protection rating and shall be supplied with thermal protection cut-out as standard.

1.5. Plate Heat Exchanger

- A. The unit shall be supplied with a Counterflow heat exchanger tested in accordance with BS EN 308:2022.
- B. The heat exchanger shall be to an efficiency of at least 83% (-5/+20 °C, 90/50% RH).
- C. The plate heat exchanger matrix shall be aerodynamically designed, with built-in spacers ensuring a constant plate separation.

1.6. Drain Pan

- A. The unit shall include a built-in condensate drain pan as standard.

1.7. Filtration

- A. The filters shall be pleated filter media as standard, with rigid wax treated cardboard moisture resistant frame.
- B. Filters shall be to BS EN ISO 16890-1:2016 Classification Grade G4 as standard, grade as indicated in the schedule and detail drawings.

1.8. Heating

- A. The units shall be available with hot water or electric element heating as indicated in the schedule and detail drawings.
- B. The hot water heater battery shall be of copper tube, aluminium fin block construction, with galvanised sheet steel casework. The flow and return pipe connections shall be handed as indicated in the schedule and detail drawings.
- C. The hot water heater battery shall be available with alternative fin coatings by special order, as indicated in the schedule.
- D. The electric heater battery shall be suitable for single-phase or three-phase supply and compatible with thyristor control as indicated in the schedule and detail drawings.
- E. The electric heater battery shall consist of an element array, sized to suit the steps and phases as indicated in the schedule and detail drawings. The elements shall consist of a tubular incolloy shroud containing compressed magnesium oxide powder packed around a nickel chromium resistance wire. The element array shall be evenly spread across the open area of the duct.
- F. Where multiple elements are required to achieve the steps and phases as indicated in the schedule, elements shall be linked by copper busbar or terminated with electrical connectors.
- G. The electric heater battery shall be fitted as standard with a thermal safety cut out, adjustable from +40 °C to +80 °C, with automatic reset.
- H. All electric heaters shall be 1500 V flash tested, and resistance tested for correct component assembly. Test certificates shall be available on request.

1.9. Operation Environment

- A. The unit shall be designed to operate in ambient temperatures from -20 °C up to +40 °C and to run continuously at up to 90% relative humidity level.

2.0. Controls

- A. The unit shall be fitted with an EC fan speed control system with max/min speed and 0-10 VDC BMS control, i.e. Air Quality or Temperature sensor as standard.
- B. The unit shall be available with optional unit mounted CPB control panel as manufactured and factory fitted by VES Andover Ltd to suit electric or hot water heating, or alternative loose CPB or CPC panel for installation by others. If no control panel is ordered, the unit shall be supplied with local isolator for unit mains connections.
- C. Fitted Controls shall be positioned as indicated in the schedule and detail drawings.
- D. Controls shall be supplied with internally mounted circuit breakers, run, trip and panel live indication and lockable door isolation switch.
- E. Control panels shall have individual circuit breakers for Supply, Extract, Control and Electric Heater Battery where indicated in the schedule and detail drawings.
- F. Fitted controls shall be supplied with a supply air duct sensor to be fitted by others on-site as indicated in the schedule.
- G. Fitted controls shall be supplied with a wired AHU mounted LCD controller unless otherwise specified. Optional room user interfaces are available.
- H. Fitted controls shall be fully pre-wired to internal components. Hot water controls shall be pre-wired to a local junction box for easy electrical connection to optional four port valve actuator supplied by VES Andover Ltd as indicated in the schedule.

2.1. Ancillaries

- A. The unit shall be fully compatible with a standard range of spigot and unit mounted silencers. The silencers shall be suitable for direct mounting to the unit.
- B. The silencer shall be a rigidly constructed single skinned galvanised sheet steel case lining incorporating internal splitting vanes lined with resin bonded mineral wool.
- C. The silencer casework shall be provided naturally finished in high quality galvanised steel as standard. Internal and External powder coat shall be available as indicated in the schedule. Colour shall be in accordance with schedule.

Product Code Guide

eCovent® Counterflow						Case Construction				Options			Ancillaries Examples	
Product	HREC Type	Unit Size	Fan Type	Fan Size	Phase	Unit Config	Heating	Infill	Handing	Main Filter	Control Panel Section	Colour	Name	Part No.
EV	CB	0	7	4	-1	/FP	[null]	/DS	/RT	/G4	/ISC	[null]	Control Panel	CPB0-1/6KW-1/P/C
		1	7	3	-1	/FW	-E	/EE	/RB	/F7	/CPSC	/R7004	Electric Heater Batter	EHEVC1/1KW/1X1
		2	6	2	-1	/SP	-W		/LT				Valve & Acuator Kit	EVCBWKT100
		3	8	5	-1	/SW			/LB				Silencer	EVCBVA300/EE/1200
		4	8	5	-1				/L				Feet	NRGX9000
									/R					

Product EV	Unit Config /FP= Flat Plantroom /FW= Flat Weatherproof /SP= Stacked Plantroom /SW= Stacked Weatherproof	Heating [null]=No Heating -E=Electric Heating -W=Water Heating	Infill DS (25mm) EE (50mm)	Handing /RT=Right Top /RB=Right Bottom /LT=Left Top /LB=Left Bottom /L=Left /R=Right	Main Filter /G4 /F7	Control Panel Section /ISC=Isolator and built in Speed Controller /CPSC=Control Panel and built in Speed Controller	Colour [null]=galv or standard WP
----------------------	--	--	---	---	----------------------------------	--	---

Example Codes
 Plantroom EVCB173-1/FP-E/RT/G4/ISC
 Weatherproof EVCB262-1/SW-W/EE/L/G4/CPSC

Other products and services from the complete range of VES HVAC solutions

Air Handling Units

- ▶ Supply and extract, combined or separate
- ▶ Heat recovery including crossflow plate heat exchangers, thermal wheels and run-around coils
- ▶ Plantroom or weatherproof, flat or stacked
- ▶ Fitted silencers, inverters and controls
- ▶ Matching DX condensing units
- ▶ Various case constructions including EN 1886 certified units

Duct Fans

- ▶ In-line centrifugal, with forward or backward curved impellers
- ▶ Round, axial and mixed flow fans
- ▶ Fitted silencers available on all units
- ▶ Manual and automatic speed controllers available

Twin Fans

- ▶ For ceiling void, plantroom and weatherproof
- ▶ Many models and configurations
- ▶ Fitted auto-changeover system

Hybrid Units

- ▶ Natural ventilation enhanced by a low power fan
- ▶ Utilises a combination of automatic mechanical ventilation and manually operated windows to achieve classroom comfort conditions
- ▶ Simple user interface with indication of operating mode
- ▶ Slimline, lightweight construction, saving space and easing installation
- ▶ Available in a range of sizes with the ability to add heating coils when required

Roof Extract Units

- ▶ Three ranges for volume and pressure
- ▶ Curb and soaker sheet bases

Wall and Ceiling Fans

- ▶ All types for commercial, industrial and domestic premises

Kitchen Hood Extract Fans

- ▶ Heavy duty high temperature fans for hot greasy air
- ▶ Motors out of airstream
- ▶ Single inlet fans, in-line and vertical jet roof units

Control Panels

- ▶ Off the shelf and built to order panels
- ▶ Air quality sensors and energy savers
- ▶ Intelligent control software
- ▶ A range of remotes including touch screen

Noise Control

- ▶ Matching silencers available for all ventilation products
- ▶ Silencers designed to meet noise criteria
- ▶ Cleanable silencers
- ▶ Weatherproof silencers

Specialist Site Services

- ▶ Plant refurbishment
- ▶ Energy saving upgrades
- ▶ Noise reduction
- ▶ Site surveys
- ▶ Kitchen ventilation
- ▶ AHU flat pack installation
- ▶ Maintenance
- ▶ Spares

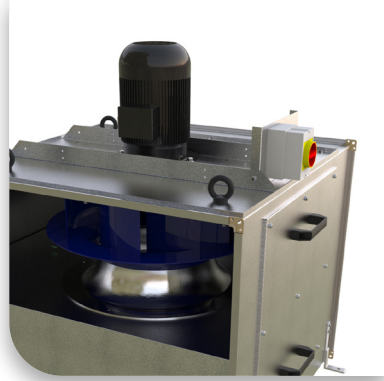
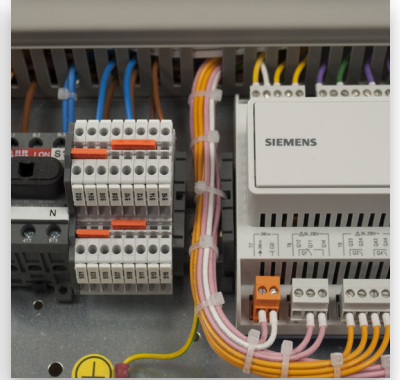
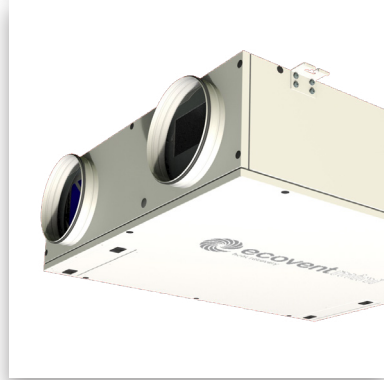
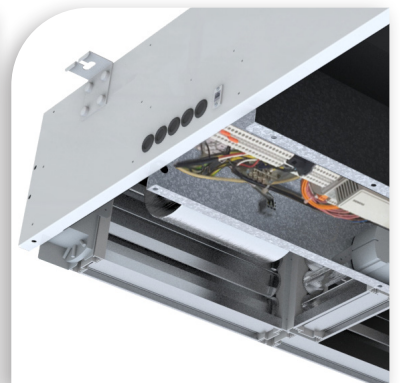
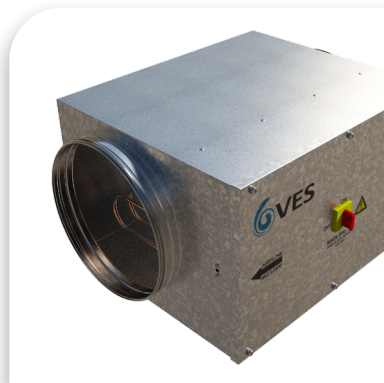

VES Head Office

Eagle Close, Chandlers Ford Industrial Estate, Chandlers Ford, Eastleigh, Hampshire SO53 4NF
Tel: +44 (0) 23 8046 1150

ves.co.uk | sales@ves.co.uk

E&OE VES reserves the right to amend product specifications and details without notice.