

# ecovent<sup>®</sup> mini

- ▶ Compact Heat Recovery Units
- ▶ ErP 1253/2014 2018 Compliant
- ▶ Heat recovery efficiency up to 90%
- ▶ Low energy EC fans
- ▶ Compact design, lightweight construction, simple installation and easy maintenance
- ▶ Low SFP to help meet L2 Building Regulations
- ▶ Options for filter grades to suit a range of requirements
- ▶ Classroom-specific options available
- ▶ Low noise to help meet acoustic requirements, including BB93
- ▶ Ancillary duct-mounted heating options
- ▶ Fitted BlueSense controls for simple installation
- ▶ BIM files available

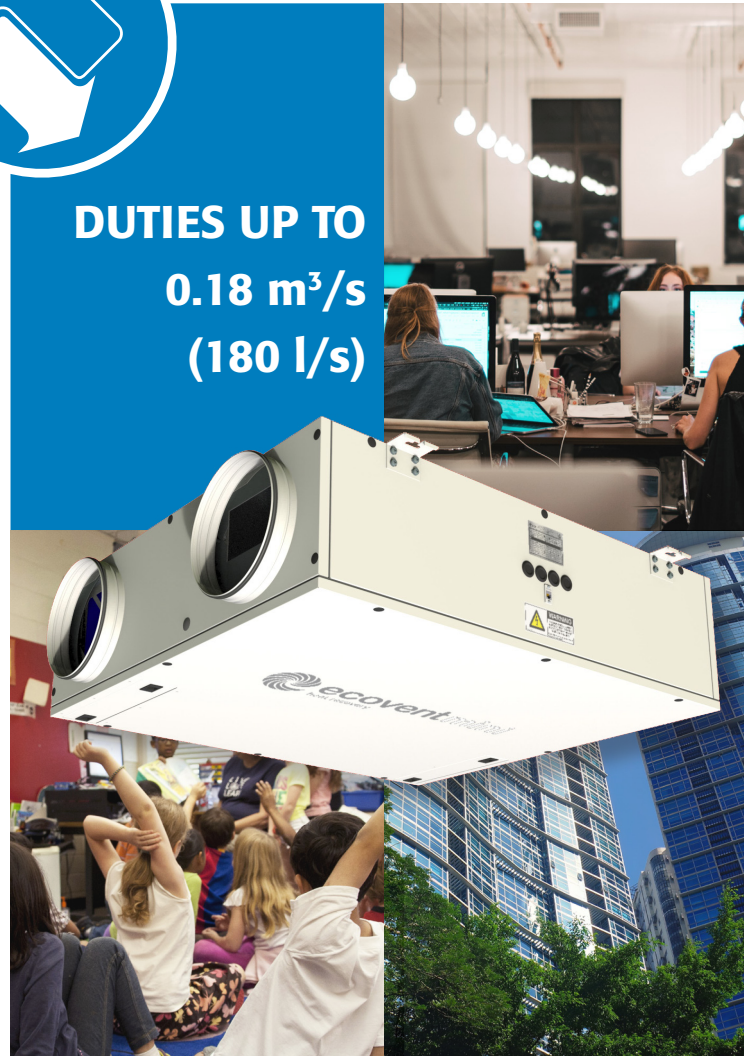

**DUTIES UP TO  
0.18 m<sup>3</sup>/s  
(180 l/s)**



## ecovent<sup>®</sup> mini

*part of the Ecovent range of innovative, flexible products  
from the HVAC experts*









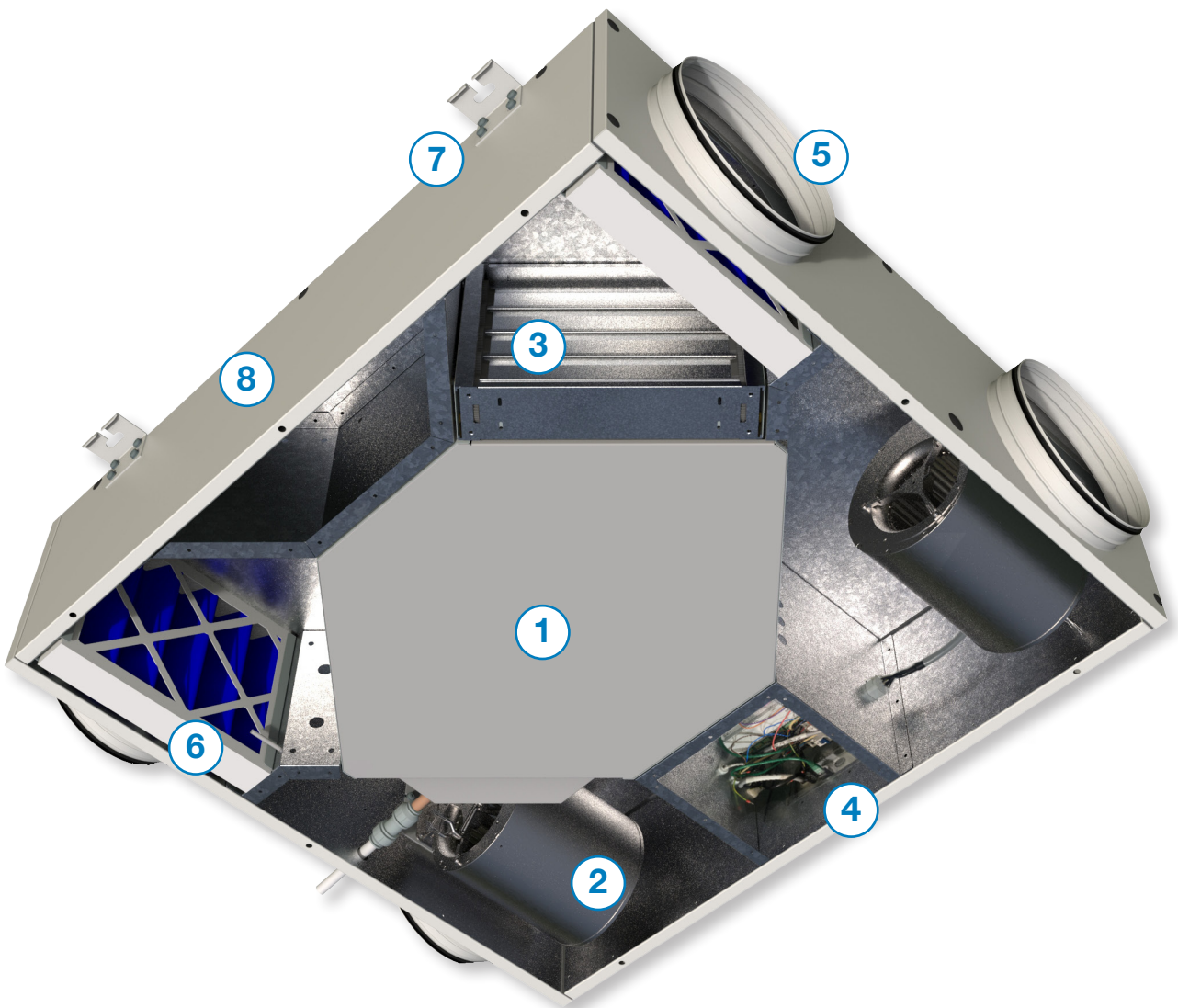



## ecovent® mini

ecovent® has been recognised as the leading brand in heat recovery air handling units for over 30 years.

Compact yet packed with impressive features, the ecovent mini is specifically crafted to meet the rigorous standards of modern building design. With its low height profile and enhanced capacity of up to 180 l/s, this range is the obvious choice, offering a combination of low Specific Fan Power and a highly efficient heat exchanger.

Ideal for a wide range of applications such as offices, schools, hotels, and retail establishments, the ecovent mini range is designed to accommodate challenging installations. Now available in three different sizes, with bottom access, its compact design makes it perfect for ceiling void and plantroom locations. With various control options available, there's an ecovent unit that will perfectly suit your needs.



|  |   |  |   |  |   |
|--|---|--|---|--|---|
| <br>Prewired/Fitted Controls | <br>Demand Ventilation | <br>Case Construction | <br>Filters  | <br>Air Quality | <br>Thyristor Heater |
| <br>Energy Efficient Fans    | <br>Speed Control      | <br>Plug & Play       | <br>Humidity | <br>Temperature | <br>Heat Recovery    |

### Energy Saving

Intelligent controls enhance performance whilst saving energy and money.

## ecovent® mini Features and Benefits

### Energy Saving

Meet regulations, minimise noise and maximise performance.

Energy saving packages combine intelligent controls technology, products and services.

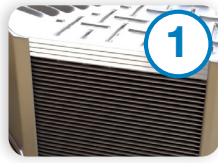

### Premium Efficiency Heat Recovery

Using the latest Computational Fluid Dynamics simulations, the counterflow plate heat exchangers in ecovent mini units have been designed to optimise airflow. This enables a true rate of heat transfer, giving efficiencies of up to 90% to BS EN 308:2022 specification and exceeding ErP requirements. The ecovent mini range also achieves zero cross contamination of moisture, smells or fumes.



### Energy Efficient

Energy efficient units with low SFPs to help achieve L2 Building Regulations. Units are fully tested to BS EN ISO 5801:2017 (airside performance).

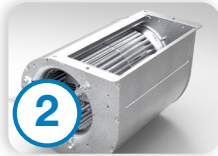

### High Performance Fans

EC fans offering maximum efficiency, minimum energy consumption. Fully controllable and ErP2015 compliant.



### Noise Reduction

Independently tested to BS EN ISO 3744:2010, units can help meet acoustic requirements for sensitive applications including BB93 (School Acoustics).

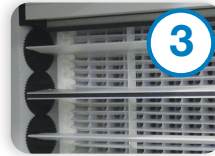

### Face & Bypass Damper

Modulating damper to efficiently control the heating/cooling recovery.

## Simple Installation and Maintenance

Simple connection and pre-installed features save onsite costs and reduce lead times. Carefully designed maintenance features minimise downtime and total cost of ownership.

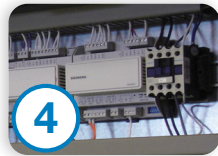

### Pre-wired Controls

Energy saving packages combine intelligent technologies. The unit is pre-wired to an integral controls package to reduce onsite wiring requirements.

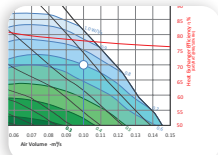

### Airflow Commissioning

Volumes for supply or extract can be adjusted at the user interface, allowing more control of demand ventilation and night set back volume.

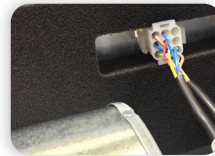

### 'Plug & Play' Fans

Fans are fitted with a quick change plug connector for easy maintenance. The fans feature EC motors and are balanced to G 2.5 / G 6.3 according to ISO 21940-11.



### Duct Connections

Easy duct connections suitable for quick on site ductwork connection ensures an efficient fit whilst minimising potential noise breakout.

## Versatile Options

Versatile location, handing and access options meet the widest range of project requirements

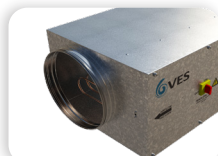

### Heating Options

Duct mounted EHB and LPHW Coil modules are available for direct connection to the unit spigot outlets. Heaters are designed to suit a range of conditions and systems.



### Filter Options

Filters are pleated media as standard, to BS EN ISO 16890 classification Coarse 65% (G4 EN 779:2012), with optional supply filters to ePM1 55% (F7 EN 779:2012).

## Robust Construction

Excellent build quality ensures minimal noise breakout, low SFPs and airtight performance

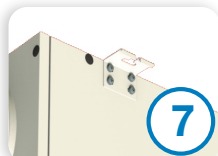

### Case Construction

The unit is constructed from double skinned galvanised sheet steel panels with mineral wool slab infill, incorporating mounting brackets compatible with drop-rod systems.



### Finish

Units are supplied painted white to RAL 9010 as standard. Bespoke casework colours and non-painted galvanised finishes are also available.

## BlueSense Energy Saving Package

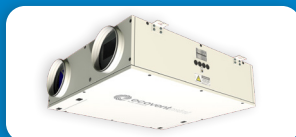

ecovent® mini with integral controls



EC fan with full control



Sensor options



The sign of energy saving products, services and expertise

## Selection data

### ecovent mini EVCM174

## Performance

$$\text{SFP} \frac{\text{Watts/litres/second}}{\text{second}} = \frac{\text{Electrical input power (Watts)}}{\text{Air volume flow rate (litres/second)}}$$

Note: SFP figures quoted at voltages tested in accordance with BS EN ISO 5801:2017 for each of the two fans.

Nominal working conditions: 0.075 m<sup>3</sup>/s (75 l/s)  
75 Pa approx = 97 W = 1.38 W/l/s  
(Unit SFP, balanced airflow)

Heat exchanger efficiency is calculated based upon EAT -5 °C and RAT +20 °C.  
The fan performance is calculated using standard G4 filters (BS EN ISO 16890 Coarse 65%).

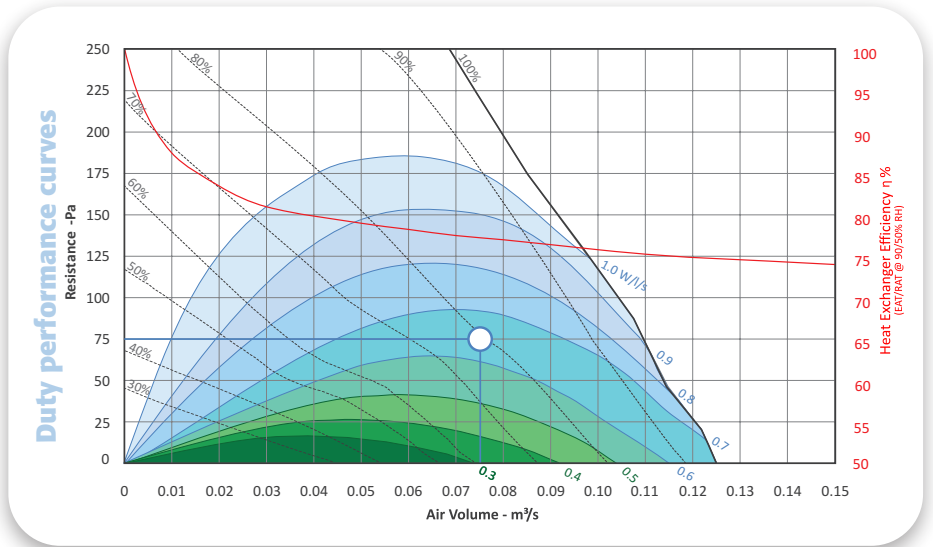

| Size      | Phase   | Motor Size | Voltage | Fan Speed | FLC    | Speed Control |
|-----------|---------|------------|---------|-----------|--------|---------------|
| EVCM174-1 | 1 Phase | 0.100 kW   | 230 VAC | 1410 rpm  | 0.83 A | EC            |

## Acoustic data

| Fan Speed | Sound Power Levels | Frequency Hz |     |     |     |    |    |    |    | Casing Radiated |       |        |        |
|-----------|--------------------|--------------|-----|-----|-----|----|----|----|----|-----------------|-------|--------|--------|
|           |                    | 63           | 125 | 250 | 500 | 1k | 2k | 4k | 8k | NR@1m           | NR@3m | dBA@1m | dBA@3m |
| 100%      | Casing Radiated    | 72           | 69  | 59  | 50  | 45 | 40 | 37 | 34 | 39              | 30    | 43     | 35     |
|           | Intake             | 74           | 71  | 68  | 60  | 60 | 58 | 52 | 43 |                 |       |        |        |
|           | Outlet             | 83           | 78  | 73  | 73  | 73 | 74 | 70 | 66 |                 |       |        |        |
| 80%       | Casing Radiated    | 68           | 64  | 53  | 45  | 40 | 33 | 30 | 28 | 33              | 24    | 37     | 30     |
|           | Intake             | 70           | 66  | 62  | 55  | 56 | 52 | 45 | 34 |                 |       |        |        |
|           | Outlet             | 76           | 73  | 67  | 67  | 68 | 67 | 62 | 57 |                 |       |        |        |
| 60%       | Casing Radiated    | 62           | 57  | 47  | 39  | 35 | 26 | 25 | 25 | 25              | 17    | 31     | 24     |
|           | Intake             | 65           | 62  | 56  | 50  | 51 | 46 | 37 | 42 |                 |       |        |        |
|           | Outlet             | 69           | 68  | 62  | 62  | 63 | 61 | 55 | 48 |                 |       |        |        |
| 40%       | Casing Radiated    | 57           | 51  | 41  | 34  | 29 | 23 | 24 | 25 | 19              | 11    | 26     | 18     |
|           | Intake             | 60           | 55  | 49  | 45  | 44 | 38 | 27 | 15 |                 |       |        |        |
|           | Outlet             | 64           | 61  | 56  | 57  | 57 | 54 | 46 | 38 |                 |       |        |        |

Sound Spectrum dB re 10<sup>-12</sup> W pWL. Units are independently tested at ISVR in accordance with BS EN ISO 3744:2010

## Unit dimensions

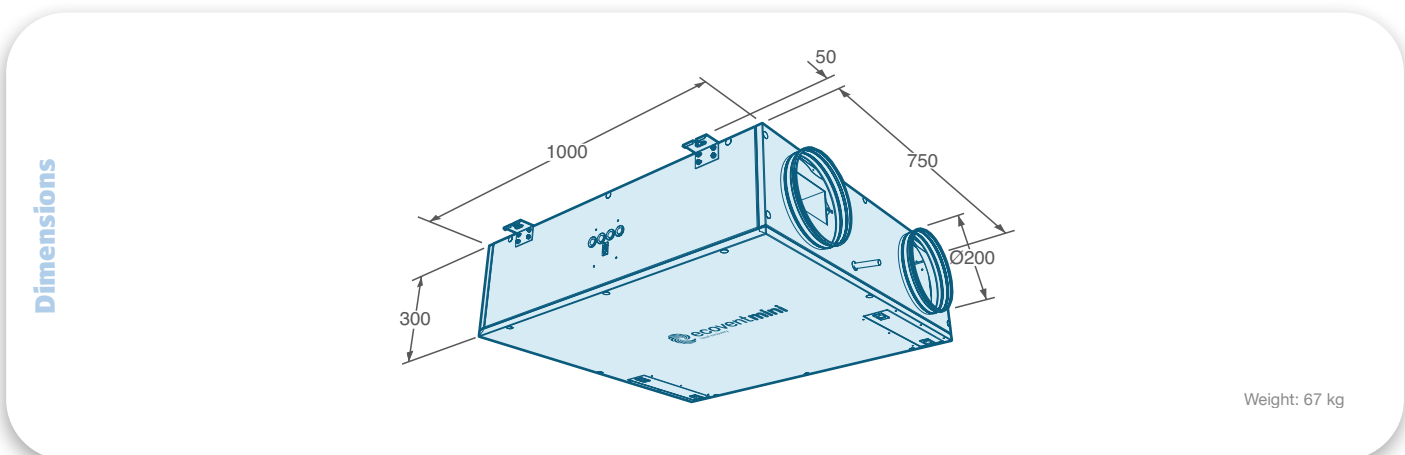

Weight: 67 kg

## Selection data

### ecovent mini EVCM274

## Performance

$$\text{SFP} \frac{\text{Watts/litres/second}}{\text{second}} = \frac{\text{Electrical input power (Watts)}}{\text{Air volume flow rate (litres/second)}}$$

Note: SFP figures quoted at voltages tested in accordance with BS EN ISO 5801:2017 for each of the two fans.

Nominal working conditions: 0.100 m<sup>3</sup>/s (100 l/s)  
100 Pa approx = 139 W = 1.39 W/l/s  
(Unit SFP, balanced airflow)

Heat exchanger efficiency is calculated based upon EAT -5 °C and RAT +20 °C.  
The fan performance is calculated using standard G4 filters (BS EN ISO 16890 Coarse 65%).

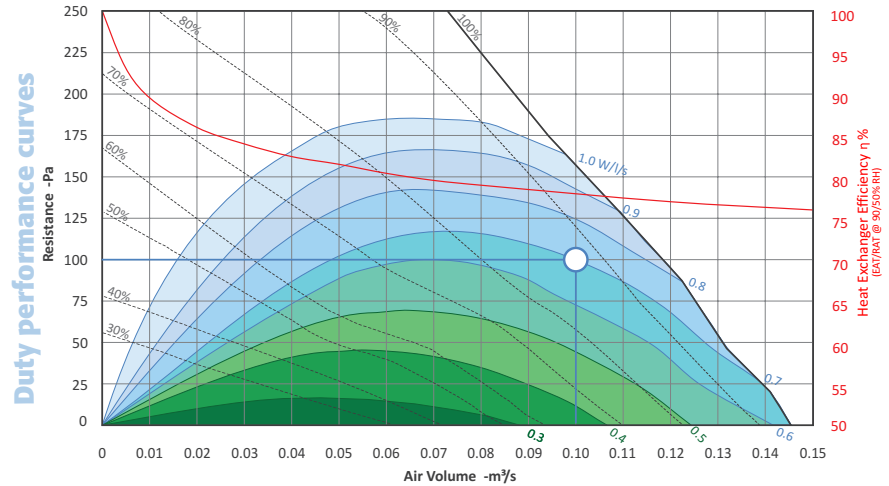

| Size      | Phase   | Motor Size | Voltage | Fan Speed | FLC    | Speed Control |
|-----------|---------|------------|---------|-----------|--------|---------------|
| EVCM274-1 | 1 Phase | 0.100 kW   | 230 VAC | 1410 rpm  | 0.83 A | EC            |

## Acoustic data

| Fan Speed | Sound Power Levels | Frequency Hz |     |     |     |    |    |    |    | Casing Radiated |       |        |        |
|-----------|--------------------|--------------|-----|-----|-----|----|----|----|----|-----------------|-------|--------|--------|
|           |                    | 63           | 125 | 250 | 500 | 1k | 2k | 4k | 8k | NR@1m           | NR@3m | dBA@1m | dBA@3m |
| 100%      | Casing Radiated    | 73           | 70  | 62  | 50  | 47 | 45 | 40 | 39 | 39              | 31    | 44     | 37     |
|           | Intake             | 74           | 71  | 68  | 60  | 60 | 58 | 52 | 43 |                 |       |        |        |
|           | Outlet             | 83           | 78  | 73  | 73  | 73 | 74 | 70 | 66 |                 |       |        |        |
| 80%       | Casing Radiated    | 68           | 65  | 58  | 44  | 41 | 37 | 33 | 31 | 35              | 27    | 39     | 32     |
|           | Intake             | 70           | 66  | 62  | 55  | 56 | 52 | 45 | 34 |                 |       |        |        |
|           | Outlet             | 76           | 73  | 67  | 67  | 68 | 67 | 62 | 57 |                 |       |        |        |
| 60%       | Casing Radiated    | 63           | 59  | 52  | 38  | 35 | 30 | 27 | 26 | 29              | 21    | 34     | 26     |
|           | Intake             | 65           | 62  | 56  | 50  | 51 | 46 | 37 | 42 |                 |       |        |        |
|           | Outlet             | 69           | 68  | 62  | 62  | 63 | 61 | 55 | 48 |                 |       |        |        |
| 40%       | Casing Radiated    | 58           | 53  | 44  | 33  | 29 | 25 | 24 | 25 | 20              | 12    | 27     | 19     |
|           | Intake             | 60           | 55  | 49  | 45  | 44 | 38 | 27 | 15 |                 |       |        |        |
|           | Outlet             | 64           | 61  | 56  | 57  | 57 | 54 | 46 | 38 |                 |       |        |        |

Sound Spectrum dB re 10<sup>-12</sup> W pWL. Units are independently tested at ISVR in accordance with BS EN ISO 3744:2010.

## Unit dimensions

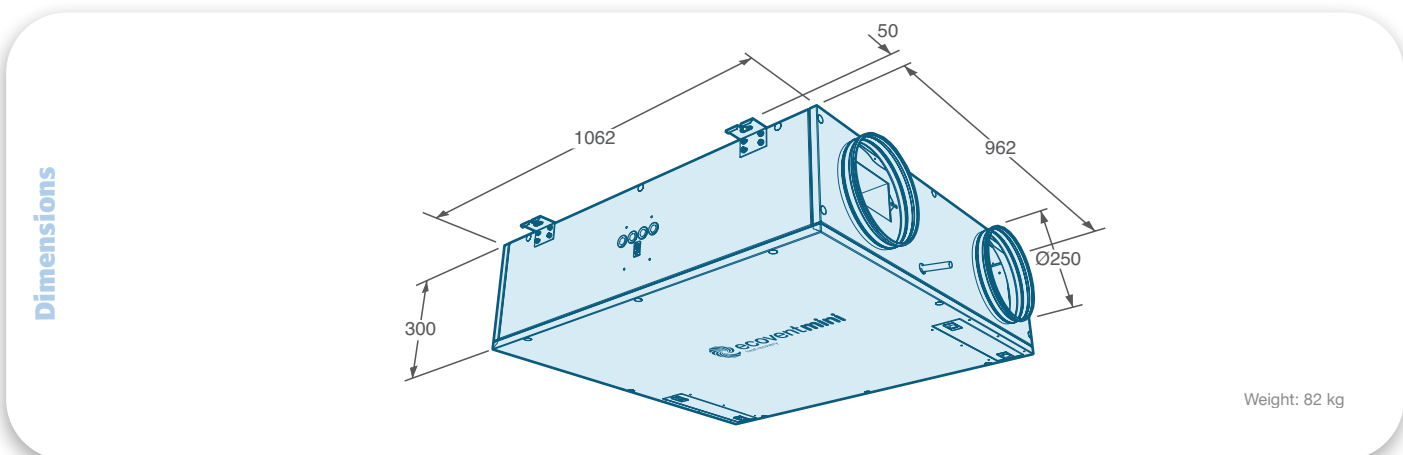

**Note:** Data for design guidance only. Detailed information is available upon request.

## Selection data

### ecovent mini EVCM353

## Performance

$$\text{SFP} \frac{\text{Watts/litres/second}}{\text{second}} = \frac{\text{Electrical input power (Watts)}}{\text{Air volume flow rate (litres/second)}}$$

Note: SFP figures quoted at voltages tested in accordance with BS EN ISO 5801:2017 for each of the two fans.

Nominal working conditions: 0.160 m<sup>3</sup>/s (160 l/s)  
100 Pa approx = 206 W = 1.28 W/l/s  
(Unit SFP, balanced airflow)

Heat exchanger efficiency is calculated based upon EAT -5 °C and RAT +20 °C.  
The fan performance is calculated using standard G4 filters (BS EN ISO 16890 Coarse 65%).

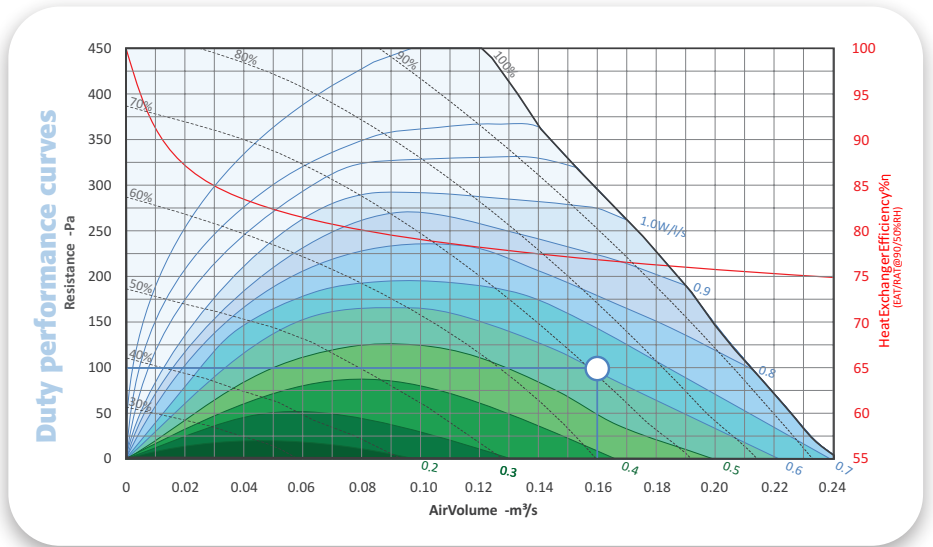

| Size      | Phase   | Motor Size | Voltage | Fan Speed | FLC    | Speed Control |
|-----------|---------|------------|---------|-----------|--------|---------------|
| EVCM353-1 | 1 Phase | 0.170 kW   | 230 VAC | 2860 rpm  | 1.75 A | EC            |

## Acoustic data

| Fan Speed | Sound Power Levels | Frequency Hz |         |         |         |         |         |         |         | Casing Radiated |       |        |        |
|-----------|--------------------|--------------|---------|---------|---------|---------|---------|---------|---------|-----------------|-------|--------|--------|
|           |                    | 63           | 125     | 250     | 500     | 1k      | 2k      | 4k      | 8k      | NR@1m           | NR@3m | dBA@1m | dBA@3m |
| 100%      | Casing Radiated    | 72           | 64      | 60      | 46      | 43      | 40      | 34      | 28      | 36              | 28    | 40     | 33     |
|           | Intake (ODA/ETA)   | 84 / 80      | 83 / 71 | 86 / 78 | 78 / 71 | 79 / 69 | 78 / 67 | 74 / 60 | 69 / 52 |                 |       |        |        |
|           | Outlet (SUP/EHA)   | 81 / 97      | 69 / 89 | 77 / 90 | 72 / 87 | 71 / 86 | 69 / 89 | 61 / 81 | 51 / 78 |                 |       |        |        |
| 80%       | Casing Radiated    | 72           | 64      | 60      | 46      | 43      | 40      | 34      | 28      | 36              | 28    | 40     | 33     |
|           | Intake (ODA/ETA)   | 84 / 80      | 83 / 71 | 86 / 78 | 78 / 71 | 79 / 69 | 78 / 67 | 74 / 60 | 69 / 52 |                 |       |        |        |
|           | Outlet (SUP/EHA)   | 80 / 98      | 69 / 90 | 77 / 87 | 72 / 84 | 71 / 83 | 69 / 85 | 61 / 78 | 51 / 74 |                 |       |        |        |
| 60%       | Casing Radiated    | 61           | 58      | 57      | 39      | 36      | 34      | 32      | 29      | 34              | 26    | 36     | 28     |
|           | Intake (ODA/ETA)   | 73 / 69      | 77 / 65 | 81 / 72 | 71 / 64 | 72 / 63 | 71 / 60 | 66 / 51 | 60 / 44 |                 |       |        |        |
|           | Outlet (SUP/EHA)   | 68 / 88      | 63 / 80 | 70 / 81 | 65 / 74 | 64 / 72 | 62 / 77 | 53 / 67 | 42 / 62 |                 |       |        |        |
| 40%       | Casing Radiated    | 53           | 55      | 43      | 29      | 26      | 25      | 25      | 26      | 21              | 13    | 27     | 19     |
|           | Intake (ODA/ETA)   | 65 / 59      | 72 / 59 | 69 / 60 | 61 / 53 | 61 / 52 | 59 / 48 | 53 / 38 | 43 / 26 |                 |       |        |        |
|           | Outlet (SUP/EHA)   | 58 / 76      | 58 / 74 | 58 / 66 | 54 / 63 | 53 / 62 | 51 / 65 | 40 / 56 | 25 / 42 |                 |       |        |        |

Sound Spectrum dB re 10<sup>-12</sup> W pW/L. Units are independently tested at ISVR in accordance with BS EN ISO 3744:2010

## Unit dimensions

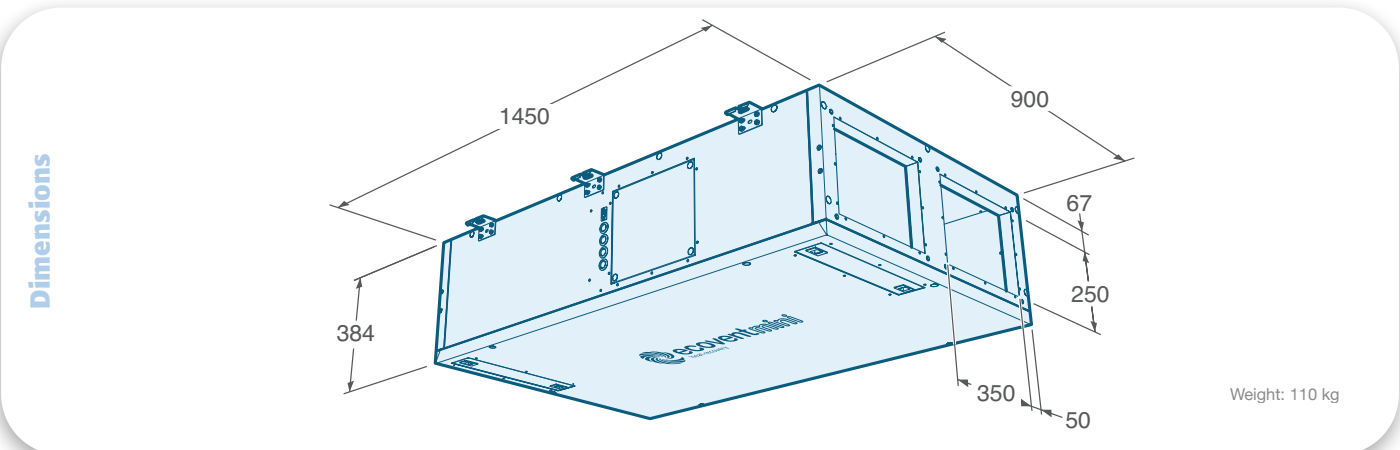

**Note:** Data for design guidance only. Detailed information is available upon request.

## ecovent® Silencers

### ecovent EVCMA1 & 2

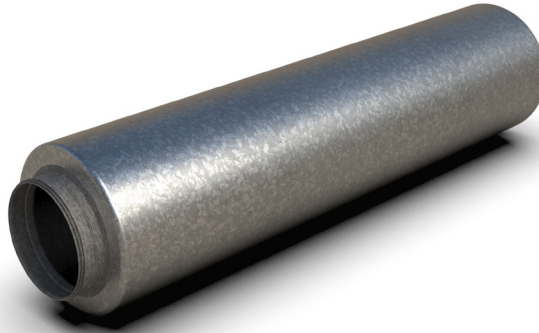

## Performance

Notes:  
Units are independently tested in accordance with BS EN ISO 3741:2010.

EVCMA2 silencers require a step-down adapter for direct fit to the unit. This is included where necessary.

Tolerances:  
On flow rates: +/- 5%  
On acoustic power and pressure: Levels: +/- 3 dB  
By octave band: +/- 5 dB

Performance curves

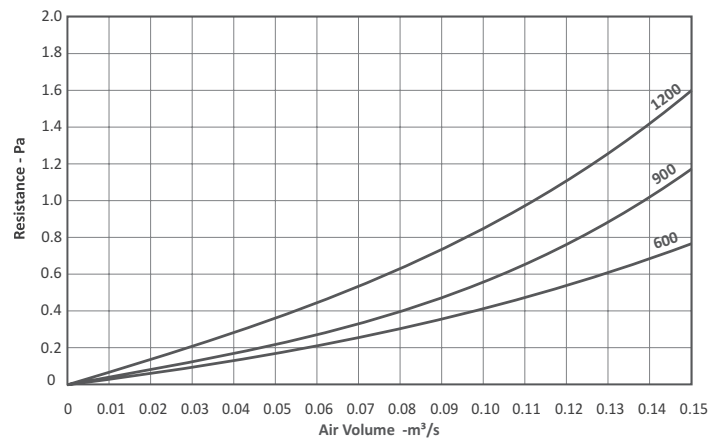

## Acoustic data

| Silencer Induct Losses | Frequency Hz |     |     |     |     |     |     |     |
|------------------------|--------------|-----|-----|-----|-----|-----|-----|-----|
|                        | 63           | 125 | 250 | 500 | 1k  | 2k  | 4k  | 8k  |
| EVCMA100/CS/0600       | -1           | -3  | -6  | -11 | -25 | -20 | -11 | -12 |
| EVCMA100/CS/0900       | -1           | -4  | -8  | -13 | -27 | -26 | -13 | -12 |
| EVCMA100/CS/1200       | -2           | -5  | -14 | -27 | -46 | -36 | -21 | -13 |
| EVCMA200/CS/0600       | -1           | -3  | -6  | -11 | -25 | -20 | -11 | -12 |
| EVCMA200/CS/0900       | -1           | -4  | -8  | -13 | -27 | -26 | -13 | -12 |
| EVCMA200/CS/1200       | -2           | -5  | -14 | -27 | -46 | -36 | -21 | -13 |

Sound Spectrum dB re 10<sup>-12</sup> W pWL. Units are independently tested in accordance with BS EN ISO 7235:2003.

## Unit dimensions

Dimensions

| Silencers        | Dimensions mm |     |      | Weight kg |
|------------------|---------------|-----|------|-----------|
|                  | A             | ØB  | ØC   |           |
| EVCMA100/CS/0600 | 600           | 300 | 200  | 7.0       |
| EVCMA100/CS/0900 | 900           | 300 | 200  | 10.0      |
| EVCMA100/CS/1200 | 1200          | 300 | 200  | 11.1      |
| EVCMA200/CS/0600 | 600           | 300 | 250* | 7.0       |
| EVCMA200/CS/0900 | 900           | 300 | 250* | 10.0      |
| EVCMA200/CS/1200 | 1200          | 300 | 250* | 11.1      |

\* adapters required

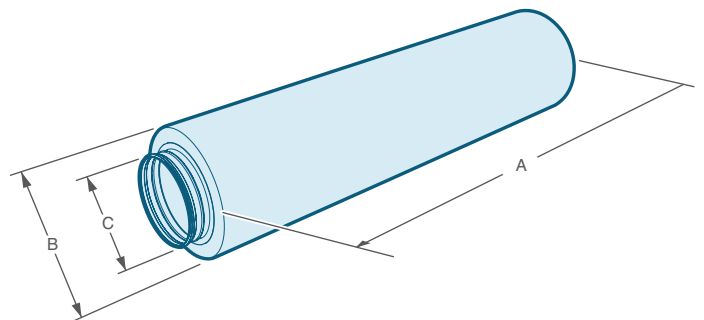

**Note:** Data for design guidance only. Detailed information is available upon request.

# ecovent® Silencers

## ecovent EVCMA3

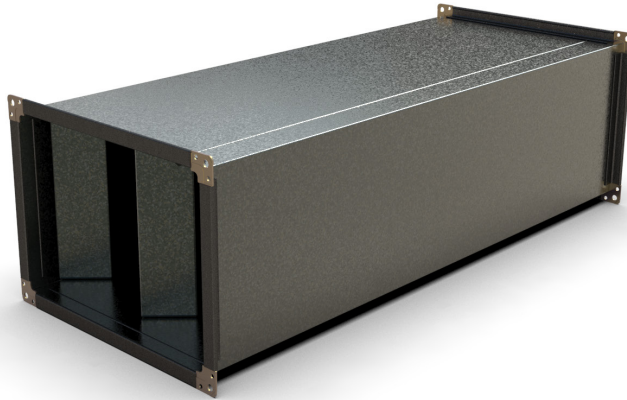

### Performance

Notes:  
Units are independently tested in accordance with BS EN ISO 3741:2010.

EVCMA3 silencers are fitted with a 20mm flange.

Tolerances:  
On flow rates: +/- 5%  
On acoustic power and pressure: Levels: +/- 3 dB  
By octave band: +/- 5 dB

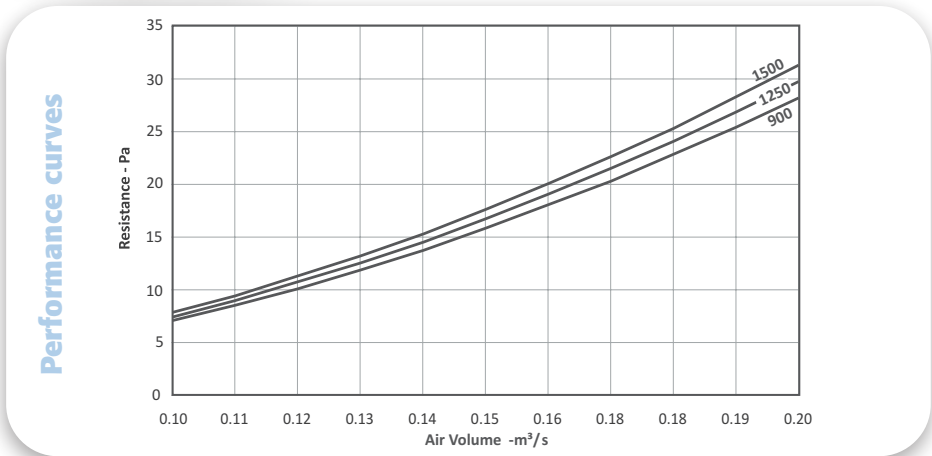

### Acoustic data

| Silencer In duct Losses | Frequency Hz |     |     |     |     |     |     |     |
|-------------------------|--------------|-----|-----|-----|-----|-----|-----|-----|
|                         | 63           | 125 | 250 | 500 | 1k  | 2k  | 4k  | 8k  |
| EVCMA300/SS/0950        | -5           | -8  | -16 | -33 | -37 | -28 | -20 | -16 |
| EVCMA300/SS/1250        | -7           | -10 | -20 | -40 | -47 | -36 | -24 | -18 |
| EVCMA300/SS/1600        | -9           | -13 | -25 | -49 | -55 | -45 | -28 | -20 |

Sound Spectrum dB re 10<sup>-12</sup> W pWL. Units are independently tested in accordance with BS EN ISO 7235:2003.

### Unit dimensions

Dimensions

| Silencers        | Dimensions mm |     |     | Weight kg |
|------------------|---------------|-----|-----|-----------|
|                  | A             | B   | C   |           |
| EVCMA300/SS/0950 | 950           | 350 | 250 | 24.0      |
| EVCMA300/SS/1250 | 1250          | 350 | 250 | 30.0      |
| EVCMA300/SS/1600 | 1600          | 350 | 250 | 39.0      |

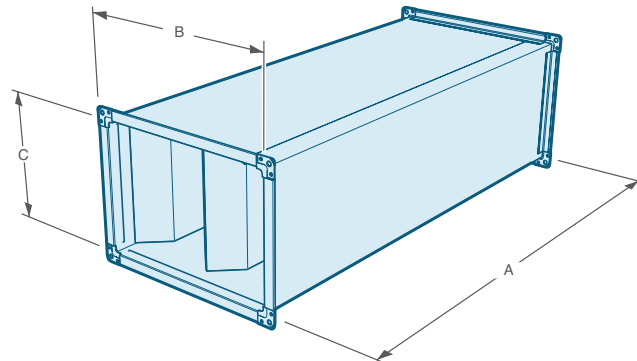



## Ecovent® Duct mounted EHB

### Ecovent EVCMEH1 & 2

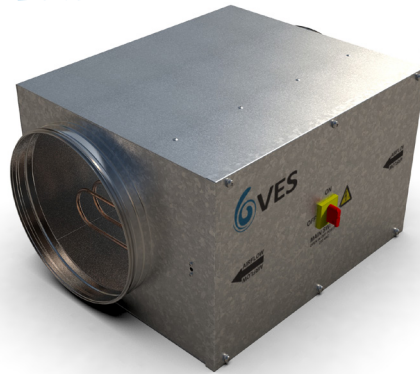

## Performance

These heaters are designed to work with ecovent mini units only, mounted directly to the unit or in-line with the adjacent ductwork. There are three sizes to match the appropriate unit, suitable for single phase supply as standard with three phase options available.

The integrated controls features a thyristor for modulating the temperature output, and an airflow pressure switch to shut off the heater in the event of airflow failure. The controls must be connected directly to the ecovent mini unit for correct operation.

Recommended minimum velocity is 1.5 m/s. For selection points outside the range shown please contact VES for further information.

Duty performance

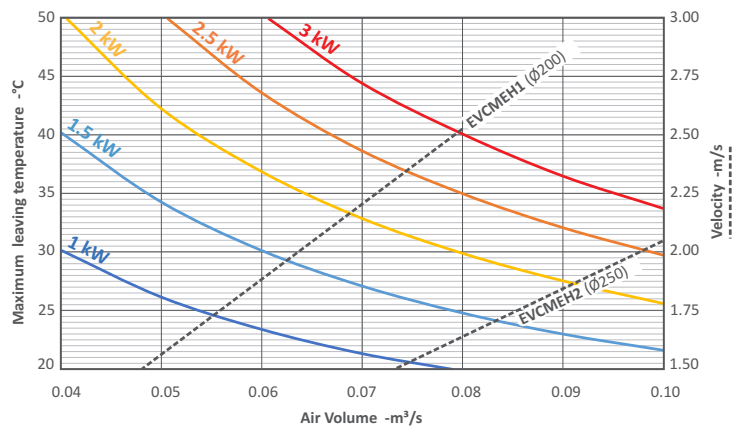

|         | Duty m³/s | Air on Temp °C | Max Air Off Temp °C | Maximum Output kW | 1Φ Electric Heater |
|---------|-----------|----------------|---------------------|-------------------|--------------------|
| EVCMEH1 | 0.05      | 9.9            | 26.2                | 1.0               | EVCMEH1/1KW/1X1    |
|         | 0.06      | 9.8            | 30.1                | 1.5               | EVCMEH1/1.5KW/1X1  |
|         | 0.07      | 9.7            | 32.9                | 2.0               | EVCMEH1/2KW/1X1    |
|         | 0.08      | 9.6            | 29.9                | 2.0               | EVCMEH1/2KW/1X1    |
| EVCMEH2 | 0.07      | 9.7            | 32.9                | 2.0               | EVCMEH2/2kW/1X1    |
|         | 0.08      | 9.6            | 29.9                | 2.0               | EVCMEH2/2kW/1X1    |
|         | 0.09      | 9.5            | 32.1                | 2.5               | EVCMEH2/2.5kW/1X1  |
|         | 0.1       | 9.4            | 33.8                | 3.0               | EVCMEH2/3kW/1X1    |

Air off temperature based upon entering air FAT -5 °C, RAT 12 °C, after the heat exchanger.  
 Power = Air Volume x Constant x Temperature Rise      kW = m³/s x 1.21 x ΔT °C

## Unit dimensions

Dimensions

| EHB         | Dimensions mm |     |     |     | Weight kg |
|-------------|---------------|-----|-----|-----|-----------|
|             | A             | B   | C   | D   |           |
| EVCMEH1/___ | 240           | 360 | 550 | 200 | 9         |
| EVCMEH2/___ | 290           | 410 | 550 | 250 | 10        |

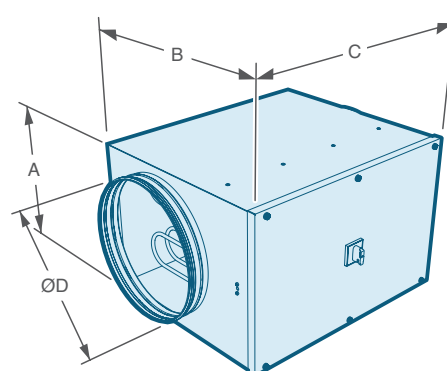

**Note:** Data for design guidance only. Detailed information is available upon request.

# ecovent® Duct mounted EHB

## ecovent EVCMEH3

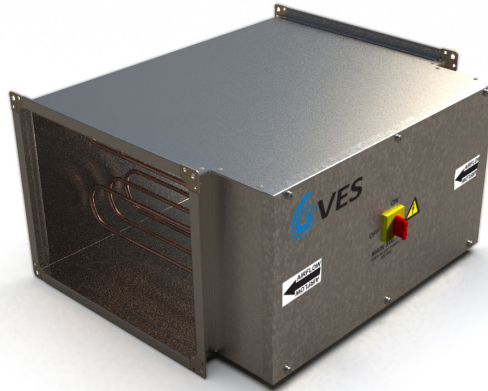

### Performance

These heaters are designed to work with ecovent mini units only, mounted directly to the unit or in-line with the adjacent ductwork. There are three sizes to match the appropriate unit, suitable for single phase supply as standard with three phase options available. The size 3 is fitted with a 20mm MEZ flange.

The integrated controls features a thyristor for modulating the temperature output, and an airflow pressure switch to shut off the heater in the event of airflow failure. The controls must be connected directly to the ecovent mini unit for correct operation.

Recommended minimum velocity is 1.5 m/s. For selection points outside the range shown please contact VES for further information.

Duty performance

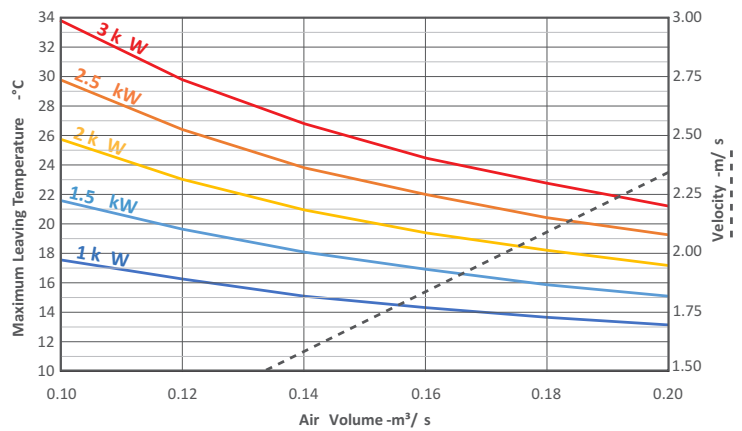

|         | Duty m³/s | Air on Temp °C | Max Air Off Temp °C | Maximum Output kW | 1Φ Electric Heater |
|---------|-----------|----------------|---------------------|-------------------|--------------------|
| EVCMEH3 | 0.10      | 9.5            | 21.7                | 1.50              | EVCMEH3/1.5KW/1X1  |
|         | 0.12      | 9.5            | 23.1                | 2.00              | EVCMEH3/2KW/1X1    |
|         | 0.14      | 9.4            | 23.9                | 2.50              | EVCMEH3/2.5KW/1X1  |
|         | 0.16      | 9.3            | 22.0                | 2.50              | EVCMEH3/2.5KW/1X1  |
|         | 0.18      | 9.2            | 22.8                | 3.00              | EVCMEH3/3KW/1X1    |
|         | 0.20      | 9.1            | 21.3                | 3.00              | EVCMEH3/3KW/1X1    |

Air off temperature based upon entering air FAT -5 °C, RAT 12 °C, after the heat exchanger.  
 Power = Air Volume x Constant x Temperature Rise      kW = m³/s x 1.21 x ΔT °C

### Unit dimensions

Dimensions

| EHB      | Dimensions mm |     |     |     | Weight kg |
|----------|---------------|-----|-----|-----|-----------|
|          | A             | B   | C   | D   |           |
| EVCMEH3_ | 250           | 472 | 630 | 350 | 15        |

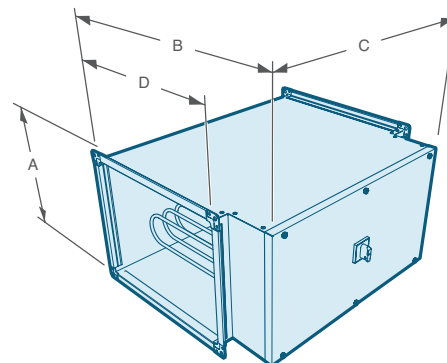

## ecovent® Duct mounted Coil

### ecovent EVCMHW1

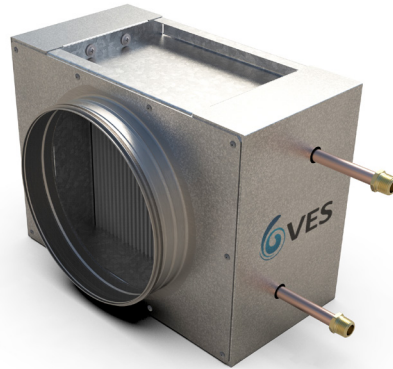

## Performance

### Performance curves

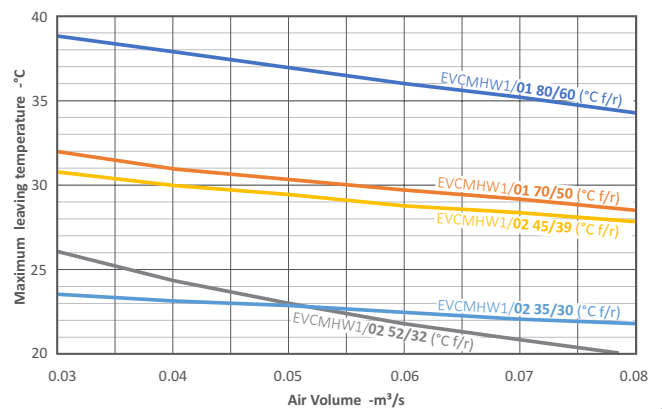
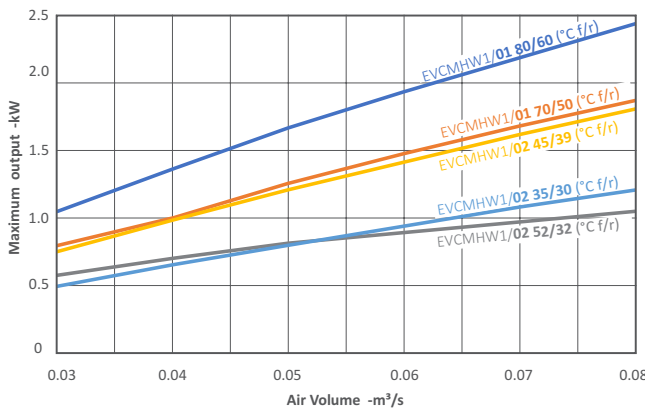

| EVCMHW1/01 | Flow/Return °C | Duty m³/s | Max Leaving Temperature °C | Max Output kW | Water Flow Rate l/s | Water Pressure Drop kPa | Air Pressure Drop Pa |
|------------|----------------|-----------|----------------------------|---------------|---------------------|-------------------------|----------------------|
|            | 80/60          | 0.04      | 0.04                       | 37.90         | 1.37                | 0.017                   | 3.00                 |
| 0.06       |                | 0.06      | 36.00                      | 1.94          | 0.024               | 3.00                    | 9                    |
| 0.08       |                | 0.08      | 34.30                      | 2.45          | 0.030               | 3.00                    | 15                   |
| 70/50      | 0.04           | 0.04      | 30.40                      | 1.01          | 0.012               | 3.00                    | 5                    |
|            | 0.06           | 0.06      | 29.70                      | 1.48          | 0.018               | 3.00                    | 9                    |
|            | 0.08           | 0.08      | 28.50                      | 1.88          | 0.023               | 3.00                    | 15                   |

| EVCMHW1/02 | Flow/Return °C | Duty m³/s | Max Leaving Temperature °C | Max Output kW | Water Flow Rate l/s | Water Pressure Drop kPa | Air Pressure Drop Pa |
|------------|----------------|-----------|----------------------------|---------------|---------------------|-------------------------|----------------------|
|            | 52/32          | 0.04      | 0.04                       | 24.30         | 0.71                | 0.009                   | 3.00                 |
| 0.06       |                | 0.06      | 21.70                      | 0.90          | 0.011               | 3.00                    | 15                   |
| 0.08       |                | 0.08      | 19.90                      | 1.05          | 0.013               | 3.00                    | 25                   |
| 45/39      | 0.04           | 0.04      | 30.00                      | 0.99          | 0.040               | 3.00                    | 7                    |
|            | 0.06           | 0.06      | 28.80                      | 1.42          | 0.057               | 3.00                    | 15                   |
|            | 0.08           | 0.08      | 27.80                      | 1.81          | 0.073               | 4.00                    | 25                   |
| 35/30      | 0.04           | 0.04      | 23.10                      | 0.66          | 0.032               | 3.00                    | 7                    |
|            | 0.06           | 0.06      | 22.40                      | 0.95          | 0.046               | 3.00                    | 15                   |
|            | 0.08           | 0.08      | 21.70                      | 1.22          | 0.059               | 3.00                    | 25                   |

Air off temperature based upon entering air FAT -5 °C, RAT 12 °C, taken after the heat exchanger.  
Coil construction copper tubes, aluminium fins, coil connections ½" BSP.  
Bespoke coils to suit alternative flow and return temperatures available upon request.

## Unit dimensions

### Dimensions

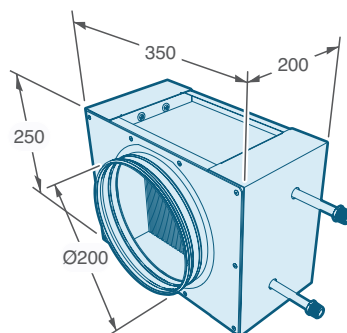

Weight: 8 kg (wet, approx)

# ecovent® Duct mounted Coil

## ecovent EVCMHW2

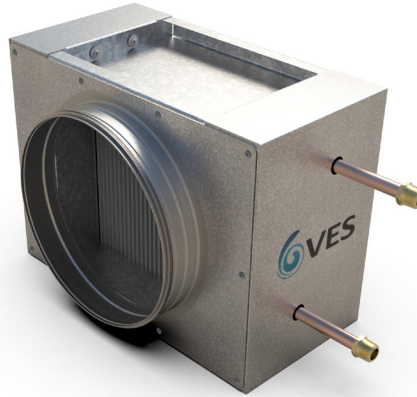

## Performance

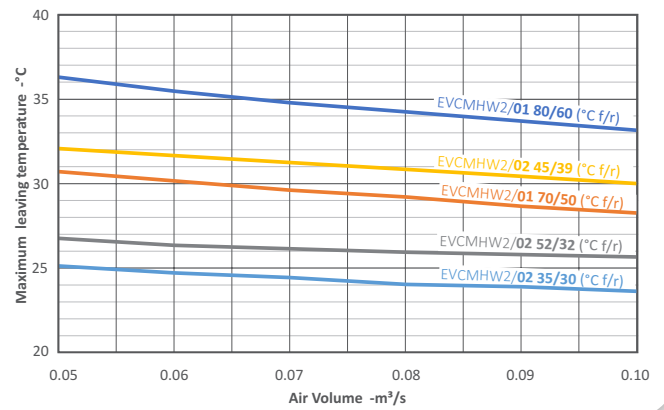
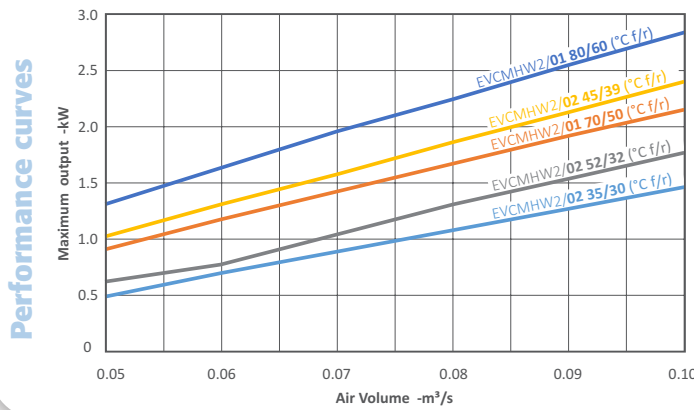

| EVCMHW2/01 | Flow/Return °C | Duty m³/s | Max Leaving Temperature °C | Max Output kW | Water Flow Rate l/s | Water Pressure Drop kPa | Air Pressure Drop Pa |
|------------|----------------|-----------|----------------------------|---------------|---------------------|-------------------------|----------------------|
|            | 80/60          |           | 0.06                       | 35.50         | 1.87                | 0.023                   | 3.00                 |
|            |                | 0.08      | 34.20                      | 2.38          | 0.029               | 3.00                    | 5                    |
|            |                | 0.10      | 33.10                      | 2.87          | 0.035               | 3.00                    | 7                    |
| 70/50      |                | 0.06      | 30.10                      | 1.48          | 0.018               | 3.00                    | 4                    |
|            |                | 0.08      | 29.20                      | 1.90          | 0.023               | 3.00                    | 5                    |
|            |                | 0.10      | 28.30                      | 2.29          | 0.028               | 3.00                    | 7                    |

Air off temperature based upon entering air FAT -5 °C, RAT 12 °C, taken after the heat exchanger.  
Coil construction copper tubes, aluminium fins, coil connections ½" BSP.  
Bespoke coils to suit alternative flow and return temperatures available upon request.

| EVCMHW2/02 | Flow/Return °C | Duty m³/s | Max Leaving Temperature °C | Max Output kW | Water Flow Rate l/s | Water Pressure Drop kPa | Air Pressure Drop Pa |
|------------|----------------|-----------|----------------------------|---------------|---------------------|-------------------------|----------------------|
|            | 52/32          |           | 0.06                       | 26.40         | 1.15                | 0.014                   | 3.00                 |
|            |                | 0.08      | 26.00                      | 1.59          | 0.019               | 3.00                    | 10                   |
|            |                | 0.10      | 25.70                      | 1.97          | 0.024               | 3.00                    | 15                   |
| 45/39      |                | 0.06      | 31.60                      | 1.59          | 0.064               | 4.40                    | 6                    |
|            |                | 0.08      | 30.80                      | 2.05          | 0.083               | 7.10                    | 10                   |
|            |                | 0.10      | 30.00                      | 2.50          | 0.101               | 10.30                   | 15                   |
| 35/30      |                | 0.06      | 24.70                      | 1.08          | 0.052               | 3.10                    | 6                    |
|            |                | 0.08      | 24.10                      | 1.41          | 0.068               | 5.00                    | 10                   |
|            |                | 0.10      | 23.60                      | 1.72          | 0.083               | 7.30                    | 15                   |

## Unit dimensions

### Dimensions

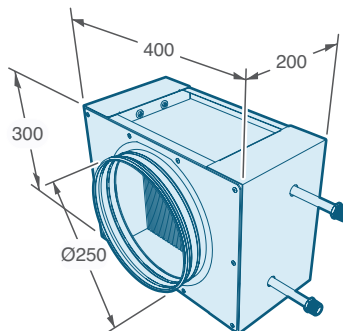

Weight: 10 kg (wet, approx)

## ecovent® Duct mounted Coil

### ecovent EVCMHW3

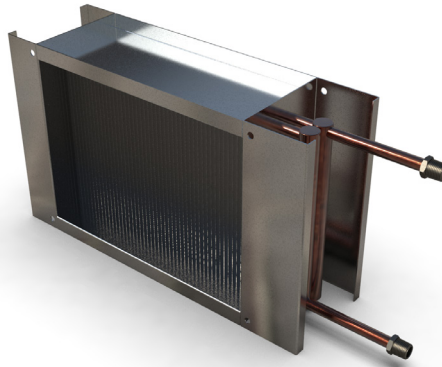

## Performance

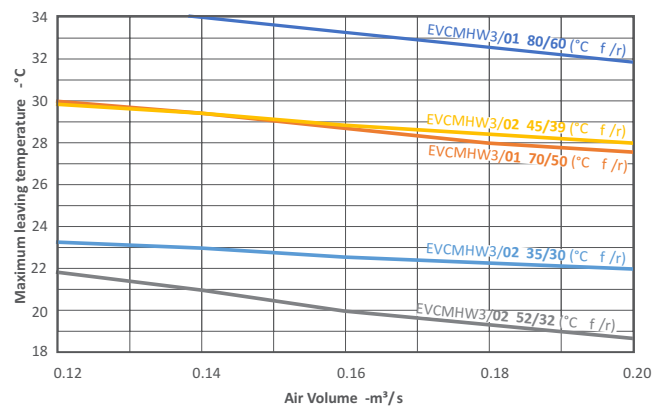
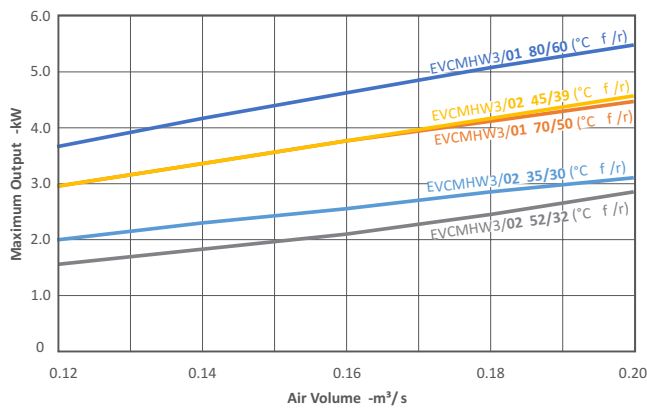

| EVCMHW3/01 | Flow/Return °C | Duty m³/s | Max Leaving Temperature °C | Max Output kW | Water Flow Rate l/s | Water Pressure Drop kPa | Air Pressure Drop Pa |
|------------|----------------|-----------|----------------------------|---------------|---------------------|-------------------------|----------------------|
|            | 80/60          |           | 0.14                       | 33.90         | 4.16                | 0.051                   | 3.00                 |
|            |                | 0.16      | 33.20                      | 4.63          | 0.056               | 3.70                    | 9                    |
|            |                | 0.18      | 32.50                      | 5.07          | 0.062               | 4.40                    | 11                   |
| 70/50      |                | 0.14      | 29.30                      | 3.37          | 0.041               | 3.00                    | 7                    |
|            |                | 0.16      | 28.60                      | 3.75          | 0.046               | 3.00                    | 9                    |
|            |                | 0.18      | 28.00                      | 4.12          | 0.050               | 3.00                    | 11                   |

| EVCMHW3/02 | Flow/Return °C | Duty m³/s | Max Leaving Temperature °C | Max Output kW | Water Flow Rate l/s | Water Pressure Drop kPa | Air Pressure Drop Pa |
|------------|----------------|-----------|----------------------------|---------------|---------------------|-------------------------|----------------------|
|            | 52/32          |           | 0.14                       | 20.90         | 1.94                | 0.023                   | 3.00                 |
|            |                | 0.16      | 20.00                      | 2.08          | 0.025               | 3.00                    | 18                   |
|            |                | 0.18      | 19.30                      | 2.20          | 0.027               | 3.00                    | 23                   |
| 45/39      |                | 0.14      | 29.30                      | 3.37          | 0.136               | 4.40                    | 15                   |
|            |                | 0.16      | 28.80                      | 3.78          | 0.152               | 5.40                    | 19                   |
|            |                | 0.18      | 28.30                      | 4.18          | 0.168               | 6.40                    | 24                   |
| 35/30      |                | 0.14      | 22.90                      | 2.28          | 0.110               | 3.10                    | 15                   |
|            |                | 0.16      | 22.50                      | 2.57          | 0.123               | 3.80                    | 19                   |
|            |                | 0.18      | 22.20                      | 2.84          | 0.137               | 4.50                    | 23                   |

Air off temperature based upon entering air FAT -5 °C, RAT 12 °C, taken after the heat exchanger.  
Coil construction copper tubes, aluminium fins, coil connections ½" BSP.  
Bespoke coils to suit alternative flow and return temperatures available upon request.

## Unit dimensions

### Dimensions

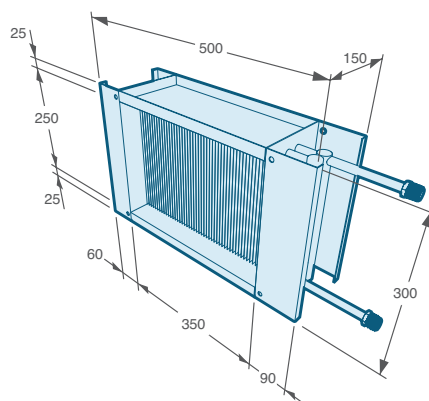

Weight: 8 kg (wet, approx)

# Control packages for performance and efficiency



## Save energy and costs with BlueSense Controls

### Demand ventilation solutions













BlueSense philosophy combines intelligent control technologies with energy saving products, services and engineering expertise. BlueSense helps meet energy reduction commitments by optimising equipment performance, improving energy efficiency, saving money and increasing equipment life expectancy.

BlueSense can be applied to a variety of projects and applications, providing efficient solutions whilst supporting design for best practice and sustainability.



### BlueSense Features

- ▶ Inbuilt intelligent controls technology
- ▶ Optimises performance and efficiency
- ▶ Demand ventilation control improves air quality, reducing energy consumption and lowering operating costs
- ▶ CO<sub>2</sub> and VOC sensing technology with energy efficient speed control
- ▶ Extending equipment life expectancy and reducing maintenance
- ▶ Short term payback on capital expenditure
- ▶ Extended warranty

|   |   |  |   |  |   |
|---|---|--|---|--|---|
| <br>Prewired/Fitted Controls | <br>Demand Ventilation | <br>Case Construction | <br>Filters  | <br>Air Quality | <br>Thyristor Heater |
| <br>Energy Efficient Fans    | <br>Speed Control      | <br>Plug & Play       | <br>Humidity | <br>Temperature | <br>Heat Recovery    |

### ecovent mini BlueSense

All products in the **ecovent** range can form part of a BlueSense energy saving package. Specify BlueSense to ensure units are optimised with pre-wired controls, energy efficient speed controller and air quality sensor.

All of these work in unison, reducing energy consumption and saving money.

### A BlueSense Example

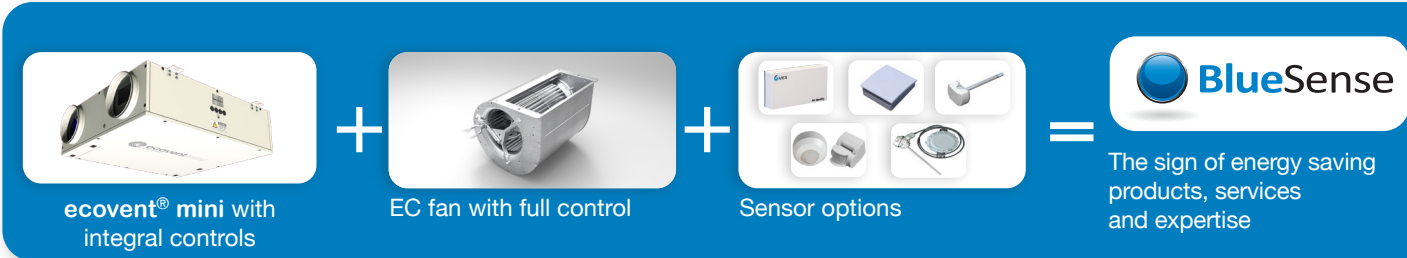

## ecovent® mini Controls - Extended Features CPEVCM

The **ecovent mini** unit with integrated controls is specifically designed for use in heat recovery applications. The CPEVCM control system is supplied fully integrated into an **ecovent mini** air handling unit to reduce installation time and costs, and can be supplied as a loose panel for installation by others if required.

### Features

- Designed, manufactured and supported by VES engineers
- Default settings for “out of the box” operation and to minimise commissioning time
- Versatile user interface and open protocol integration option
- Easily identified field terminals to assist installation and maintenance
- Extensive parameter adjustment to optimise installation and further improve system efficiency
- Optional energy monitoring providing real time energy consumption and efficiency information

### Specification for CPEVCM for Heat Recovery Applications

| Features   | CPEVCM |
|--|--------|
| Fitted and pre-wired within <b>ecovent mini</b> or traditional loose panel options | ✓      |
| Heat recovery damper modulation, free heating and cooling optimisation             | ✓      |
| Modulating electric heating control option   | ✓      |
| Frost protection and heating demand output for water coils option                  | ✓      |
| Temperature philosophy; supply, return or return + supply limits                   | ✓      |
| 7 day time clock   | ○      |
| Condensate pump control  | ○      |
| Demand ventilation; Air Quality, constant pressure                                 | ○      |
| Filter dirty indication; inputs for DP switches                                    | ✓      |
| Fan run-on and safety interlocks   | ✓      |
| Remote start / stop via removable link   | ✓      |
| Common trip indication   | ✓      |
| Fire alarm shutdown, 24 VDC  | ○      |
| Inlet and return damper  | ○      |
| Remote user interface, full function   | ✓      |
| Remote user interface, full function touch screen                                  | ○      |
| Energy monitoring with real time display   | ○      |
| Heat recovery efficiency with real time display                                    | ○      |
| Integration by Modbus over RS485 open protocol or ethernet BACnet MS/TP            | ✓      |
| Integration by BACnet/IP open protocol   | ○      |
| Bespoke to suit requirement  | ○      |
| <b>BlueSense - Energy Saving Package</b>   | ✓      |
| <b>Energy efficient speed control</b>  | ✓      |
| <b>Demand Control</b>  | ✓      |
| <b>Post installation Commissioning</b>   | ○      |

○ = Option



### BlueSense includes an Extended Warranty

- 3 years with BlueSense packages
- 5 years with BlueSense package and Post Installation Commissioning

Please quote BlueSense with your order or contact our specialist sales team for further information. Call +44 (0)2380 46 11 50 or Email [sales@ves.co.uk](mailto:sales@ves.co.uk)

## Product Specification

### ecovent® mini (EVCM) Compact Heat Recovery Units

#### 1.1. General

A. Provide a heat recovery air handling unit to meet the performance and configuration as indicated in the schedule and detail drawings. The heat recovery air handling unit shall be tested to BS EN ISO 5801:2017 and shall be of the ecovent type as manufactured by VES Andover Ltd, a company accredited with BS EN ISO 9001:2015.

#### 1.2. Unit Construction

- A. The unit shall be provided pre-assembled comprising double skinned galvanised sheet steel panels, supply and extract centrifugal fans with direct drive motor, supply and extract G4 pleated panel filters, and plate heat exchanger with drain pan.
- B. The construction shall be tested in accordance with BS EN 1886:2007.
- C. The unit shall be supplied in one section.
- D. The unit shall be available in plantroom construction as indicated in the schedule and detail drawings.
- E. The unit shall be fitted with a heat exchanger bypass duct, incorporating a face and bypass damper to allow heating / cooling recovery.
- F. The units shall have either circular safe-fit spigots compatible with spiral ductwork, or rectangular connections compatible with 20mm MEZ flange connections as indicated in the schedule and detail drawings.
- G. The unit casework shall incorporate high quality rubber gasket seals on service doors and panels.
- H. Access for maintenance shall be via a removable panel, allowing access for the cleaning or removal of internal components as indicated in the detail drawings. The filters shall be bottom withdrawal as standard.
- I. Flat plantroom casework shall incorporate mounting brackets compatible with drop-rod systems.
- J. The unit shall be supplied in the configuration: flat, plantroom. Access and handing options shall be as indicated in the schedule and detail drawings.

#### 1.3. Fans

- A. The fan impellers shall be statically and dynamically balanced to G 2.5 / G 6.3 according to ISO 21940-11:2016.
- B. The fan impellers shall be mated with aerodynamic bell inlet eyes for high efficiency and low noise generation.
- C. The fan impellers shall be supplied in natural uncoated finish as standard.

#### 1.4. Motors

- A. The fans shall incorporate external rotor motors to insulation class F, IP4X environmental protection rating and shall be supplied with thermal protection cut-out as standard.

#### 1.5. Plate Heat Exchanger

- A. The unit shall be supplied with a Counterflow heat exchanger tested in accordance with BS EN 308:2022.
- B. The heat exchanger shall be to an efficiency of at least 75% (-5/+20 °C, 90/50% RH).
- C. The plate heat exchanger matrix shall be aerodynamically designed, with built-in spacers ensuring a constant plate separation.

#### 1.6. Drain Pan

- A. The unit shall include a built-in condensate drain pan as standard.

#### 1.7. Filtration

- A. The filters shall be pleated filter media as standard, with rigid wax treated cardboard moisture resistant frame.
- B. Filters shall be to BS EN ISO 16890 classification Coarse 65% (G4 EN 779:2012) as standard, grade as indicated in the schedule and detail drawings.

#### 1.8 Heating

- A. The unit shall come with no heating as standard. Options for duct mounted ancillary heating are available as indicated in the schedule.



## Product Specification continued

### 1.9. Operation Environment

A. The unit shall be designed to operate in ambient temperatures from -20 °C up to +40 °C and to run continuously at up to 90% relative humidity level.

### 2.0. Controls

A. The unit shall be fitted with an EC fan speed control system with min/max speed and 0-10 VDC BMS control

B. Temperature sensor shall be fitted as standard.

C. Fitted controls shall be positioned as indicated in the schedule and detail drawings.

D. Controls shall be supplied with internally mounted circuit breakers.

E. Fitted controls shall be supplied with a supply air duct sensor to be fitted by others onsite as indicated in the schedule.

F. Fitted controls shall be fully pre-wired to internal components.

### 2.1. Ancillaries

A. The unit shall be fully compatible with a standard range of spigot mounted silencers. The silencers shall be suitable for direct mounting to the unit.

B. The silencer shall be a rigidly constructed double skinned galvanised sheet steel case lined with resin bonded mineral wool.

C. The silencer casework shall be provided naturally finished in high quality galvanised steel as standard. External powder coat shall be available as indicated in the schedule. Colour shall be in accordance with schedule.

D. The units shall be available with duct mounted hot water or electric element heating as indicated in the schedule and detail drawings, suitable for direct fitting to the end of the unit.

E. The duct mounted hot water heater battery shall be of copper tube, aluminium fin block construction, with galvanised sheet steel casework.

F. The duct mounted hot water heater battery shall be available with alternative fin coatings by special order, as indicated in the schedule.

G. The duct mounted electric heater battery shall be suitable for single-phase supply and compatible with thyristor control as indicated in the schedule and detail drawings.

H. The duct mounted electric heater battery shall consist of an element array, sized to suit the steps and phases as indicated in the schedule and detail drawings. The elements shall consist of a tubular incoloy shroud containing compressed magnesium oxide powder packed around a nickel chromium resistance wire. The element array shall be evenly spread across the open area of the duct.

I. Where multiple elements are required to achieve the steps and phases as indicated in the schedule, elements shall be linked by copper busbar or terminated with electrical connectors.

J. The duct mounted electric heater battery shall be fitted as standard with a thermal safety cut out, adjustable from +40 °C to +80 °C, with automatic reset.

K. All duct mounted electric heaters shall be 1500 V flash tested, and resistance tested for correct component assembly. Test certificates shall be available on request.

| ecovent <sup>®</sup> Counterflow |           |           |          |          |       | Case Construction |         |        |         | Options     |                       |          | Ancillaries Examples   |                 |
|----------------------------------|-----------|-----------|----------|----------|-------|-------------------|---------|--------|---------|-------------|-----------------------|----------|------------------------|-----------------|
| Product                          | HREC Type | Unit Size | Fan Type | Fan Size | Phase | Unit Config       | Heating | Infill | Handing | Main Filter | Control Panel Section | Colour   | Name                   | Part No.        |
| EV                               | CM        | 1         | 7        | 4        | -1    | /FP               | [null]  | /DS    | /RB     | /G4         | /ISC                  | [null]   | Duct Mounted LPHW Coil | EVCMHW1/01      |
|                                  |           | 2         | 7        | 4        | -1    |                   |         |        | /LB     | /F7         | /CPSC                 | /R9010LT | Duct Mounted EHB       | EVCMEH2/3kW/1X3 |
|                                  |           | 3         | 5        | 3        | -1    |                   |         |        |         |             |                       |          | Valve & Acuator Kit    | EVCMCWKT100     |
|                                  |           |           |          |          |       |                   |         |        |         |             |                       |          | Silencer               | EVCMA300/1250   |

Product  
EV (ecovent)

Unit Config  
/FP= Flat Plantroom

Heating  
[null] =No Heating

Infill  
DS = Double Skinned

Handing  
Plantroom /RB=Right Bottom  
Flat /LB=Left Bottom

Main Filter  
/G4  
/F7

Control Panel Section  
/CPSC=Control Panel and  
built in Speed Controller

Colour  
NULL = Galvanised  
/R9010LT= RAL9010  
in leatherette finish

#### Example Codes

Plantroom EVCM174-1/FP/RB/G4/CPSC/R9010LT

Other products and services from the complete range of VES HVAC solutions

### Air Handling Units

- ▶ Supply and extract, combined or separate
- ▶ Heat recovery including crossflow plate heat exchangers, thermal wheels and run-around coils
- ▶ Plantroom or weatherproof, flat or stacked
- ▶ Fitted silencers, inverters and controls
- ▶ Matching DX condensing units
- ▶ Various case constructions including EN 1886 certified units

### Duct Fans

- ▶ In-line centrifugal, with forward or backward curved impellers
- ▶ Round, axial and mixed flow fans
- ▶ Fitted silencers available on all units
- ▶ Manual and automatic speed controllers available

### Twin Fans

- ▶ For ceiling void, plantroom and weatherproof
- ▶ Many models and configurations
- ▶ Fitted auto-changeover system

### Hybrid Units

- ▶ Natural ventilation enhanced by a low power fan
- ▶ Utilises a combination of automatic mechanical ventilation and manually operated windows to achieve classroom comfort conditions
- ▶ Simple user interface with indication of operating mode
- ▶ Slimline, lightweight construction, saving space and easing installation
- ▶ Available in a range of sizes with the ability to add heating coils when required

### Roof Extract Units

- ▶ Three ranges for volume and pressure
- ▶ Curb and soaker sheet bases

### Wall and Ceiling Fans

- ▶ All types for commercial, industrial and domestic premises

### Kitchen Hood Extract Fans

- ▶ Heavy duty high temperature fans for hot greasy air
- ▶ Motors out of airstream
- ▶ Single inlet fans, in-line and vertical jet roof units

### Control Panels

- ▶ Off the shelf and built to order panels
- ▶ Air quality sensors and energy savers
- ▶ Intelligent control software
- ▶ A range of remotes including touch screen

### Noise Control

- ▶ Matching silencers available for all ventilation products
- ▶ Silencers designed to meet noise criteria
- ▶ Cleanable silencers
- ▶ Weatherproof silencers

### Specialist Site Services

- ▶ Plant refurbishment
- ▶ Energy saving upgrades
- ▶ Noise reduction
- ▶ Site surveys
- ▶ Kitchen ventilation
- ▶ AHU flat pack installation
- ▶ Maintenance
- ▶ Spares

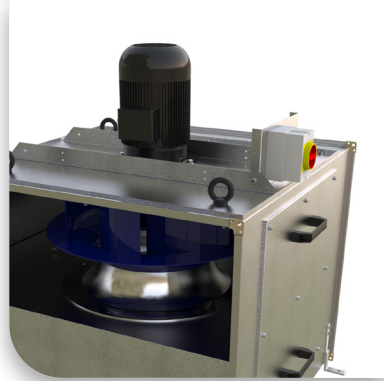
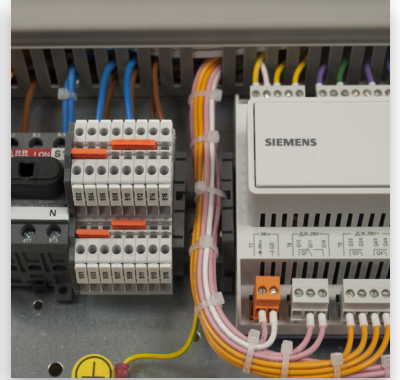
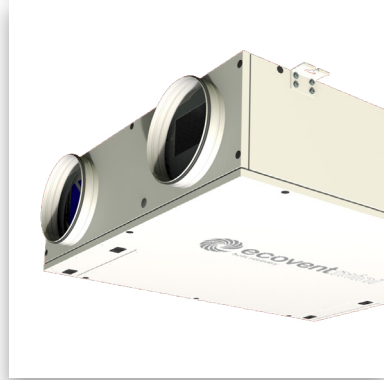
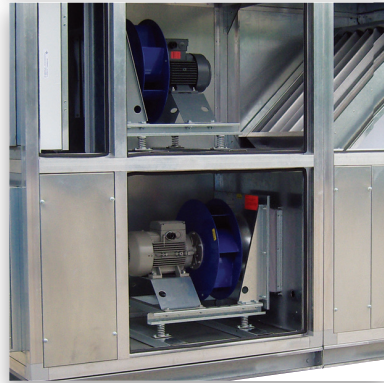
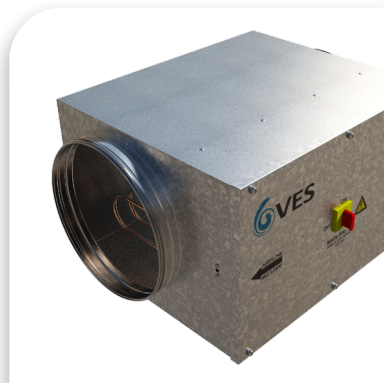

#### VES Head Office

Eagle Close, Chandlers Ford Industrial Estate, Chandlers Ford, Eastleigh, Hampshire SO53 4NF  
Tel: +44 (0) 23 8046 1150 Fax: +44 (0)23 8026 1204

[ves.co.uk](http://ves.co.uk) | [sales@ves.co.uk](mailto:sales@ves.co.uk)

VES reserves the right to amend product specifications and details without notice.